

# EUROMASK®



SILICONE ADHESIVE - NASTRI CARTA - STAMPATI SPECIALI - BIADESIVI  
TAPPI - HOOKS - NASTRI ADESIVI - CAPS - STAMPATI SPECIALI - CUT

# EMK

CORDS - CAPPUCCI - SILICONE FOAMS - GANCI - DIE CUTS - PLUGS - FLT  
POLYIMIDE TAPES - AUTOAGGLOMERANTE - SPECIAL ENGINEERED - EPDM



Powered by  
**FINISHING GROUP srl**



Sistema Qualità Certificato  
Certified Quality System

RELEASE  
**EMK  
K23 I**

**"WE SOLVE  
EVERY MASKING  
PROBLEM"**

## IL NOSTRO IMPEGNO PER LA TERRA IN CUI VIVIAMO

Euromask® è sensibile e attenta alla sostenibilità ambientale e si sforza di contribuire a un mondo più protetto in cui l'industria sia innovativa, responsabile e sostenibile. Crediamo infatti **che i nostri figli e le generazioni future abbiano il diritto di ricevere un mondo sano e pulito**, dove vivere in piena salute e sicurezza: per questo ci impegniamo in prima persona a preservare il pianeta e le sue risorse riducendo emissioni e impatto ambientale.

Il nostro impegno per la sostenibilità nasce dai Valori iscritti nel nostro DNA: **responsabilità, serietà**, attenzione alla **salute** e alla **sicurezza**, rispetto per le persone e per l'ambiente. Già da tempo abbiamo attivato procedure in questa direzione, ma abbiamo deciso di impegnarci ancora di più. **Oggi Euromask® è ancora più sostenibile.**

Ecco cosa facciamo nel concreto:

- **Zero emissioni** - Catalogo cartaceo stampato su carta 100% riciclabile con inchiostri a base acqua. Il catalogo è ora prodotto a emissione zero.
- **Riciclo** - imballi di cartone 70% carta riciclata e 100% riciclabili, stampati con inchiostri a base acqua.
- **Riuso** - Euromask® favorisce il riuso utilizzando per i Clienti gli imballaggi dei propri Fornitori.
- **Plastic free** - Non utilizziamo più materiale pluriball.
- **Riciclo** - Prodotti confezionati con sacchetti in plastica 100% riciclata e 100% riciclabile stampata con inchiostri ad acqua. Per i nastri impieghiamo esclusivamente mandrini in materiali 100% riciclabili.
- **Riuso** - Studiamo appositamente i nostri prodotti nel rispetto dei principi del riutilizzo e del riuso.
- **Riduzione e riciclo** - Ci impegniamo a ridurre lo scarto prodotto e a smaltire correttamente il rimanente.
- **Riduzione** - Preveniamo l'inquinamento e minimizziamo il nostro impatto ambientale ottimizzando costantemente i processi di realizzazione dei nostri articoli, per azzerare gli sprechi e ridurre al minimo i consumi di risorse ed energia.
- **Riciclo** - Nella produzione puntiamo a utilizzare esclusivamente prodotti in materiali 100% riciclabili.
- **Compensazione** - "Piantiamo insieme 3 milioni di alberi!". Compensiamo la produzione per contrastare gli effetti del cambiamento climatico.

### Il nostro impegno

- Nella scelta dei Fornitori, privilegiamo quanti condividono la nostra attenzione all'ambiente.
- Ricerchiamo con continuità le migliori soluzioni possibili in termini di tecnologia ed efficienza per essere sempre all'avanguardia.
- Teniamo sempre in considerazione i potenziali effetti sull'ambiente di tutti gli sviluppi nuovi o pianificati delle nostre attività, prodotti e servizi.
- Promuoviamo misure gestionali e comportamenti delle persone orientati al rispetto dell'ambiente.

### Riuso e riciclo

Quando un prodotto finisce il suo ciclo di vita è buona norma **riciclarlo**, riportarlo cioè a materia prima. Il riciclo ha comunque un costo ambientale.

**Riuso**, invece, significa utilizzare lo stesso prodotto più volte. Il riuso non ha costi; anzi: ogni volta che si riusa, il costo ambientale originale di produzione viene ridotto!

### Cerca nel catalogo Euromask® i nuovi simboli del riuso:



Questo prodotto si può utilizzare più volte



Questo prodotto si può utilizzare con diametri diversi

Anche tu puoi contribuire a dare ai nostri figli un mondo che non sia solo un rifiuto: fai come noi.

- Favorisci il riuso e il riutilizzo dei materiali: ogni volta azzeri i costi energetici e gli inquinanti per produrli, risparmi e non produci rifiuti!
- Non buttare i nostri imballi, utilizzali per le tue spedizioni.
- Smaltisci correttamente gli scarti: i nostri sacchetti e mandrini sono tutti 100% riciclabili.

**TUTTI INSIEME PER L' AMBIENTE**



# WE SOLVE EVERY MASKING PROBLEM

## OUR COMMITMENT FOR THE EARTH WE LIVE IN

Euromask® is sensitive to environmental sustainability and strives to contribute to a more protected world in which industry is innovative, responsible and sustainable. In fact, we believe **that our children and future generations have the right to receive a healthy and clean world**, where they can live in full health and safety: this is why we're personally engaged to preserve the planet and its resources by reducing emissions and environmental impact.

Our engagement to sustainability rises from the values inscribed in our DNA: **responsibility, seriousness**, attention to **health** and **safety** and respect for people and the environment. We've been implementing procedures in this direction for a long time, but recently we decided to commit ourselves even more.

**Today Euromask® is even more sustainable.**

Here's what we do in practice:

- **Zero emissions** - Catalogue printed on 100% recyclable paper and water-based inks. The catalogue is now a zero emission product.
- **Recycling** - Packages made at 70% recycled and 100% recyclable PAP printed with water-based inks.
- **Reuse** - Euromask® favors reuse by using the packagings of its Suppliers for its Customers.
- **Plastic free** - We no longer use bubble wrap material.
- **Recycling** - Products packaged with 100% recycled and 100% recyclable plastic bags printed with water-based inks. For the Tapes we only use cores made of 100% recyclable materials.
- **Reuse** - We specifically study our products in compliance with the principles of reuse .
- **Reduction and recycling** - We are committed to reduce our waste and to properly dispose of it
- **Reduction** - We prevent pollution and minimize our environmental impact by constantly optimizing the manufacturing processes of our items, to eliminate waste and minimize the consumption of resources and energy.
- **Recycling** - In production we aim to use only products made of 100% recyclable materials.
- **Compensation** - "Let's plant 3mln trees together!". We offset production to counter the effects of ongoing climate change.

### Our commitment

- Choosing suppliers, we favor those who share our attention to the environment.
- We continuously search for the best solutions in terms of technology and efficiency to be always at the forefront.
- We always consider carefully the potential effects on the environment of all new or planned developments of our activities, products and services.
- We promote management measures and people's behaviors oriented to the respect of the environment.

### Reuse and Recycling

When a product ends its life, it's good habit to **recycle** it in order to bring it back to raw material. However, recycling has an environmental cost.

**Reuse**, on the other hand, means using the same product several times. Reuse has no cost: every time we reuse something the original environmental cost of production is reduced!!

### Look for the new reuse logos into Euromask® catalog:



This product can be used several times



This product can be used with different diameters

You can actively contribute to give our children a world that is not just a garbage: follow us!

- Promote the reuse of materials: every time you eliminate the energy costs and pollutants to produce them, you do not produce waste and you save money!
- Don't throw away our packagings, use them for your shipments.
- Dispose of your waste properly: our bags and cores are 100% recyclable.

**TOGETHER FOR THE PLANET**

# EUROMASK®



*Euromask® è leader nella produzione e distribuzione di sistemi professionali di mascheratura per tutti i trattamenti superficiali. Da ormai 20 anni, Euromask® distribuisce in tutto il mondo la sua ampia gamma di tappi, cappucci, ganci per la verniciatura, nastri e bollini, tubi e prodotti stampati speciali.*

**Velocità, flessibilità e professionalità** sono le parole chiave del successo di Euromask®:

- Evasione dell'85% degli ordini in 24/48 ore
- 130 milioni di pezzi a magazzino
- Campionatura in tempi brevi: per gli adesivi in 3-4 giorni e produzione in 10 di giorni, per gli stampati in 1 settimana e produzione in 4 settimane.

Sistemi di mascheratura per le operazioni di verniciatura a polvere, liquido, anodizzazione e cromatura. Tappi conici e cappucci per la protezione di fori e filetti nelle operazioni di verniciatura, resistenti fino a 315°C. e riutilizzabili. Nastri e bollini adesivi per le operazioni di verniciatura a polveri e nei processi galvanici, metallizzazione e anodizzazione.

**Condizioni di vendita: Spedizione a mezzo corriere espresso. Ordine minimo € 75,00**

**Schede tecniche disponibili a richiesta  
Catalogo valido da Aprile 2023**

Finishing Group s.r.l. si riserva il diritto di apportare modifiche ai prodotti, prezzi e condizioni di fornitura senza alcun preavviso.



# WE SOLVE EVERY MASKING PROBLEM



*Euromask® is a leader in the production and distribution of professional masking systems for all surface treatments. Since 20 years Euromask® has been distributing its wide range of plugs, caps and painting hooks, tapes and discs, tubing and special moulded products worldwide.*

**Speed, flexibility and professionalism** are the key words to Euromask®'s success:

- Execution of 85% of orders within 24/48 hours
- 130 million pieces in stock
- Fast sampling times: for adhesives 3-4 days with production in about ten days, for moulded items 1 week with production in 4 weeks.

Masking systems for powder and liquid painting operations, anodizing and chromium plating. Conical plugs and caps for the protection of holes and threads in painting operations. Resisting up to 315°C. and reusable. Tapes and adhesive disks for masking operations in powder painting and galvanic processes, metallization and anodizing.

**Sales Terms: Shipment by express carrier. Minimum order € 75,00**

**Technical data sheets availables on demand**  
**Catalog available from April 2023**

Finishing Group s.r.l. reserve to make any necessary modification to products, prices and supply conditions without notice.

## HOOKS



Altre forme e dimensioni realizzabili a richiesta  
Other sizes and drawings on demand



Ganci in acciaio e ferro per verniciatura.



Steel and iron hooks for painting.



HC



HV

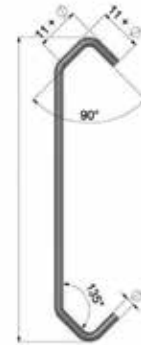

TIPO 5

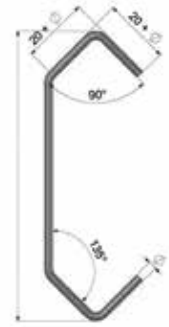

TIPO 6

| LUNGHA<br>LENGTH | Ø 1,5 mm |        | Ø 2 mm |        | Ø 3 mm |        | Ø 4 mm |        | Ø 5 mm |        |
|------------------|----------|--------|--------|--------|--------|--------|--------|--------|--------|--------|
|                  | Q.ty     | Price  | Q.ty   | Price  | Q.ty   | Price  | Q.ty   | Price  | Q.ty   | Price  |
| 60 mm            | 5000     | 134,17 | 5000   | 162,99 | 2500   | 166,30 | 1500   | 251,31 | 1000   | 262,21 |
| 75 mm            | 5000     | 138,98 | 5000   | 171,17 | 2000   | 150,76 | 1000   | 167,02 | 500    | 142,81 |
| 100 mm           | 5000     | 147,04 | 3000   | 110,95 | 2000   | 172,28 | 1000   | 186,62 | 500    | 154,53 |
| 150 mm           | 2500     | 93,29  | 2500   | 114,20 | 1500   | 160,44 | 500    | 113,05 | 500    | 193,40 |
| 200 mm           | 2000     | 87,78  | 1500   | 77,37  | 1000   | 118,42 | 500    | 129,23 | 250    | 116,13 |
| 250 mm           | 1000     | 49,17  | 1000   | 65,72  | 500    | 75,92  | 500    | 152,12 | 250    | 135,56 |
| 300 mm           | 500      | 27,40  | 500    | 36,27  | 750    | 127,37 | 500    | 159,86 | 250    | 154,99 |
| 350 mm           | 500      | 31,51  | 500    | 41,16  | 750    | 133,37 | 500    | 166,75 | 250    | 174,43 |
| 400 mm           | 500      | 56,28  | 500    | 45,08  | 500    | 93,18  | 250    | 88,83  | 250    | 193,86 |

piega-bend-pivotée-Verdrehung-plega: 45° - 90° - 180° - **PREZZO - PRICE : +15%**

## SW



Ganci girevoli.



Swivel hooks.

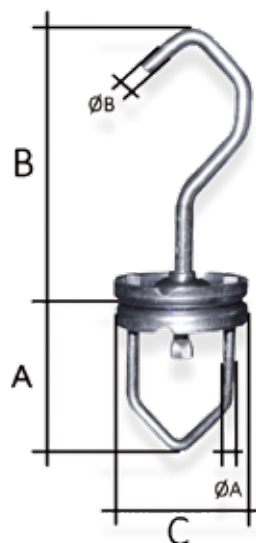

| CODICE<br>CODE | A  | B   | C    | D    | Ø A | Ø B | PREZZO CAD.<br>PRICE EACH |
|----------------|----|-----|------|------|-----|-----|---------------------------|
| SW V           | 60 | 100 | 49,5 | -    | 5   | 7   | € 9,19                    |
| SW V CROWN     | 60 | 100 | 88   | -    | 5   | 7   | € 11,49                   |
| SW C           | 53 | 75  | 47,7 | 17,5 | 5   | 6   | € 9,19                    |



## H-VERT

Altre forme  
e dimensioni  
realizzabili a richiesta  
Other sizes and drawings  
on demand

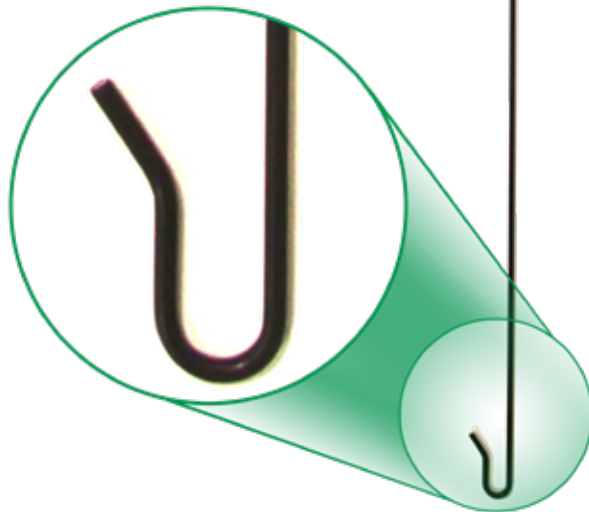

Ganci in acciaio per verniciatura in verticale di profili in alluminio.



Steel hooks for vertical painting of Aluminium profiles.

## Ganci Speciali Special Hooks



**Ganci Speciali.**

Produzione di grossi o piccoli volumi realizzati a disegno del cliente. Rapidità di approntamento. Adatti per verniciatura e saldatura.



**Special Hooks.**

Low or High volume quantities. Made on customer's bespoke drawings. Fast turnaround. Suitable for painting and welding.

# EUROMASK®

## CUT



**Distributore automatico taglianastro.**  
Taglio spezzoni da 20 a 999 mm di nastri adesivi larghi da 8 a 50 mm



**Automatic tape-cut dispenser.**  
To cut adhesive tape pieces from 20 to 999mm LENGTH and from 8 to 50mm width

Prezzo  
PRICE  
**€ 789,90**

## TAI

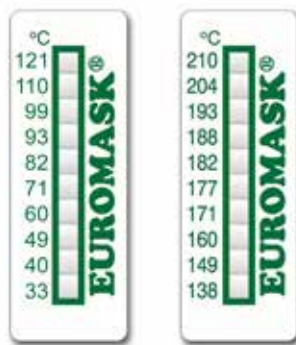

**Termometri autoadesivi monouso.**  
Graduati per controllo della temperatura all'interno del forno.



**Self-adhesive thermometers (single-use).**  
Graded for temperature control inside the oven.

**CODICE  
CODE**

**SCALA  
RANGE**

**PREZZO CAD.  
PRICE EACH**

TAI010 (10 pz)  
TAI009 (10 pz)

138 °C - 210 °C  
33°C - 121 °C

€ 35,94  
€ 35,94

## STICKRP01



**Stick per ritocco verniciatura a polvere.**



**Custom made touch-up pencils for powder coating**

**CODICE  
CODE**

**PZ. SCAT.  
PCS. BOX**

**PREZZO CAD.  
PRICE EACH**

STICKRP01  
STICKRP01  
STICKRP01

fino a 50 PZ / up to 50 PCS  
fino a 100 PZ / up to 100 PCS  
fino a 250 PZ / up to 250 PCS

€ 14,30  
€ 12,65  
€ 11,00



# PRO



### Vernice spray HQS.

Studiata per il ritocco professionale. Ampia gamma di colori RAL. Elevata durata nel tempo senza ingiallire, senza cambiare colore e senza staccarsi dal materiale.



### Spray paint HQS.

Sudied for professional retouching work. Wide range of RAL colors. High long-time resistance without yellowing, without changing color and without detaching from the material.



| CODICE CODE     | COLORI COLOURS  | PZ. CONF. PCS. BOX | €/CONF. €/BOX |
|-----------------|---|--------------------|---------------|
| <b>PRO</b>      | Colori vari RAL - <i>Various RAL colours</i>  | 6                  | € 23,96       |
| <b>PROTRASP</b> | Trasparente opaco o lucido - <i>Glossy transparent or opaque</i>                    | 6                  | € 23,96       |
| <b>PRO9006</b>  | Argento - <i>Silver</i>   | 6                  | € 25,41       |
| <b>PRO-ANT</b>  | Antiruggine / Bianco / Grigio / Rosso<br><i>Antirust / White / Grey / Rusty red</i> | 6                  | € 25,41       |

**SRT**  
15mts



**IT**

**Nastro silicone autoagglomerante.**

Nastro in silicone senza adesivo. Il nastro fondendosi su se stesso forma una pellicola omogenea resistente fino a 300 °C. Il nastro ha tempi di stoccaggio limitati.

**GB**

**Self-agglomerating silicone rubber tape.**

Silicone rubber tape without adhesive. The tape vulcanized on itself, forms an homogeneous cover that can withstand temperatures of up to 300°C. Limited shelf life.

| CODICE<br>CODE | ALTEZZA<br>SIZE | LUNGH.<br>LENGTH | PZ. SCAT.<br>RLS BOX | €/ROT.<br>€/ROLL | €/SCAT. (CAD.)<br>€/BOX (EACH) |
|----------------|-----------------|------------------|----------------------|------------------|--------------------------------|
| SRT25          | 25 mm           | 15 m             | 20                   | 66,29            | 53,03                          |

**AAP**  
250mts

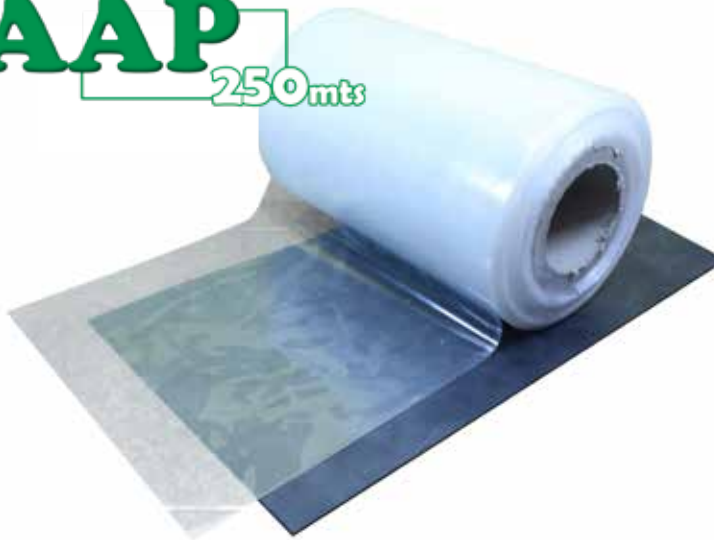

**IT**

**Pellicola autoadesiva trasparente**

Per la protezione delle cabine di verniciatura a liquido.

**GB**

**Transparent self-adhesive film**

For the protection of liquid spray booths.

| CODICE<br>CODE | ALTEZZA<br>SIZE | LUNGH.<br>LENGTH | €/ROT.<br>€/ROLL |
|----------------|-----------------|------------------|------------------|
| AAP1180-250    | 300 mm          | 250 m            | € 103,81         |
| AAP1575-250    | 400 mm          | 250 m            | € 138,42         |
| AAP1970-250    | 500 mm          | 250 m            | €173,02          |



# WE SOLVE EVERY MASKING PROBLEM

|                       |     |     |    |    |    |    |    |    |    |    |    |    |     |     |
|-----------------------|-----|-----|----|----|----|----|----|----|----|----|----|----|-----|-----|
| altezza - size mm     | 5   | 10  | 12 | 15 | 20 | 25 | 30 | 35 | 40 | 45 | 50 | 80 | 100 | 150 |
| pz./scat. - rolls/box | 150 | 100 | 80 | 70 | 50 | 40 | 40 | 30 | 30 | 30 | 30 | 20 | 10  | 10  |

EPTL escluso - except EPTL

## HPT

55mts

**SCONTO 25%**  
acquisto box completo

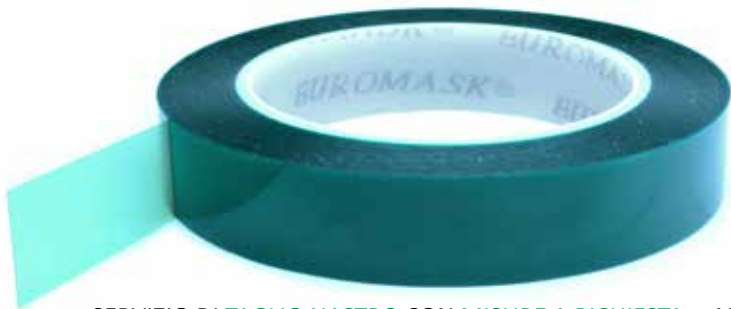

SERVIZIO DI TAGLIO NASTRO CON MISURE A RICHIESTA. ALTEZZE DISPONIBILI DA 3 A 1105 mm CON PASSO 1 mm  
BESPOKEN THICKNESS CUT SERVICE. SIZE BETWEEN 3 TO 1105 mm, STEP BY 1 mm

## EPR

66mts

**SCONTO 20%**  
acquisto box completo



SERVIZIO DI TAGLIO NASTRO CON MISURE A RICHIESTA. ALTEZZE DISPONIBILI DA 3 A 1105 mm CON PASSO 1 mm  
BESPOKEN THICKNESS CUT SERVICE. SIZE BETWEEN 3 TO 1105 mm, STEP BY 1 mm

## EPB

66mts

**SCONTO 20%**  
acquisto box completo

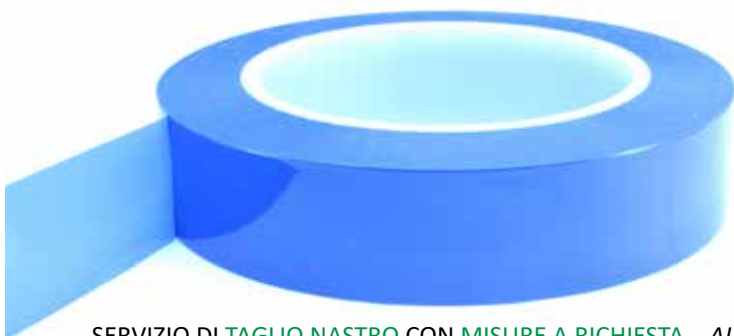

SERVIZIO DI TAGLIO NASTRO CON MISURE A RICHIESTA. ALTEZZE DISPONIBILI DA 3 A 1105 mm CON PASSO 1 mm  
BESPOKEN THICKNESS CUT SERVICE. SIZE BETWEEN 3 TO 1105 mm, STEP BY 1 mm



### Nastro verde 204 °C

Per rivestimenti a polvere e applicazioni di anodizzazione. Una volta rimosso lascia una superficie pulita, senza residui di adesivo. 0,05 mm di poliestere - 0,04 mm di adesivo.



### Green tape 204 °C

Powder coating and anodizing applications. Clean removal, no adhesive residue. 0,05 mm polyester - 0,04 mm silicone adhesive.

Prezzo  
0,375/mm



### Nastro rosso 220°C

Per rivestimenti a polvere e applicazioni di anodizzazione. Una volta rimosso lascia una superficie pulita, senza residui di adesivo. 0,025 mm di poliestere - 0,07 mm di adesivo



### Red tape 220 °C

Powder coating and anodizing applications. Clean removal, no adhesive residue. 0,025 mm polyester - 0,07 mm silicone adhesive.

Prezzo  
0,792/mm



### Nastro Blu 204 °C

Per rivestimenti a polvere e applicazioni di anodizzazione. Adatto alle superfici curve. Una volta rimosso lascia una superficie pulita, senza residui di adesivo. 0,025 mm di poliestere - 0,05 mm di adesivo.



### Blue tape 204 °C

Powder coating and anodizing applications. Suitable for curved surfaces. Clean removal, no adhesive residue. 0,025 mm polyester - 0,05 mm silicone adhesive.

Prezzo  
0,662/mm

## EPTXL

500mts

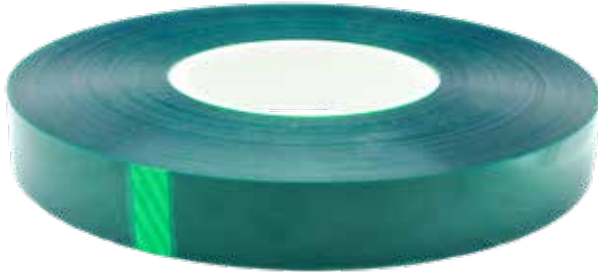

IT

### Nastro verde 204 °C

Per rivestimenti a polvere e applicazioni di anodizzazione. Una volta rimosso lascia una superficie pulita, senza residui di adesivo. 0,05 mm di poliestere - 0,04 mm di adesivo.

GB

### Green tape 204 °C

Powder coating and anodizing applications. Clean removal, no adhesive residue. 0,05 mm polyester - 0,04 mm silicone adhesive.

Prezzo  
Price **3,751/mm**

SERVIZIO DI TAGLIO NASTRO CON MISURE A RICHIESTA. ALTEZZE DISPONIBILI DA 15 A 480 mm CON PASSO 1 mm  
BESPOKEN THICKNESS CUT SERVICE. SIZE BETWEEN 15 TO 480 mm, STEP BY 1 mm

## STC

66mts

**SCONTO 20%**  
acquisto box completo



IT

### Nastro trasparente 204 °C.

Per rivestimenti a polvere e applicazioni di anodizzazione. Adatto per superfici curve. Una volta rimosso lascia una superficie pulita, senza residui di adesivo. 0,025 mm di poliestere - 0,04 mm di adesivo.

GB

### Clear tape 204 °C.

Powder coating and anodizing applications. Adapted to curved surfaces. Clean removal, no adhesive residue. 0,025 mm polyester, 0,04 mm silicone adhesive.

Prezzo  
Price **0,577/mm**

SERVIZIO DI TAGLIO NASTRO CON MISURE A RICHIESTA. ALTEZZE DISPONIBILI DA 3 A 1105 mm CON PASSO 1 mm  
BESPOKEN THICKNESS CUT SERVICE. SIZE BETWEEN 3 TO 1105 mm, STEP BY 1 mm

## CLT

66mts

**SCONTO 20%**  
acquisto box completo



IT

### Nastro trasparente 204 °C.

Per rivestimenti a polvere e applicazioni di anodizzazione. Una volta rimosso lascia una superficie pulita, senza residui di adesivo. 0,05 mm di poliestere - 0,04 mm di adesivo.

GB

### Clear tape 204 °C.

Powder coating and anodizing applications. Clean removal, no adhesive residue. 0,05 mm polyester - 0,04 mm silicone adhesive.

Prezzo  
Price **0,576/mm**

SERVIZIO DI TAGLIO NASTRO CON MISURE A RICHIESTA. ALTEZZE DISPONIBILI DA 3 A 1105 mm CON PASSO 1 mm  
BESPOKEN THICKNESS CUT SERVICE. SIZE BETWEEN 3 TO 1105 mm, STEP BY 1 mm



## PC

33mts

**SCONTO 20%**  
acquisto box completo



SERVIZIO DI TAGLIO NASTRO CON MISURE A RICHIESTA. ALTEZZE DISPONIBILI DA 3 A 1000 mm CON PASSO 1 mm  
BESPOKEN THICKNESS CUT SERVICE. SIZE BETWEEN 3 TO 1000 mm, STEP BY 1 mm



### Nastro polimide 260 °C.

Per rivestimenti a polvere ed elettrostatici per immersione liquida. Una volta rimosso lascia una superficie pulita, senza residui. Ottima resistenza chimica. 0,025 mm di polimide 0,04 mm di adesivo siliconico.



### Polyimide tape 260 °C.

Recommended for powder coating and E-coating. Clean removal, no adhesive residue. Excellent chemical resistance. 0,025 mm polyimide - 0,04 mm silicone adhesive.

Prezzo  
Price  
**0,563/mm**

## EGC

50mts

**SCONTO 20%**  
acquisto box completo



SERVIZIO DI TAGLIO NASTRO CON MISURE A RICHIESTA. ALTEZZE DISPONIBILI DA 3 A 1075 mm CON PASSO 1 mm  
BESPOKEN THICKNESS CUT SERVICE. SIZE BETWEEN 3 TO 1075mm, STEP BY 1 mm



### Nastro in tessuto di fibra-vetro 260 °C.

Indicato per la flammizzazione e per rivestimenti a polvere. Resistente alla sabbatura ad alta pressione, all'abrasione e ai solventi.



### Glass Cloth tape 260 °C.

Recommended for thermal spray and powder coating. Resistant to high pressure blasting, abrasion and to solvents.

Prezzo  
Price  
**1,323/mm**

## FLT

33mts

**SCONTO 20%**  
acquisto box completo

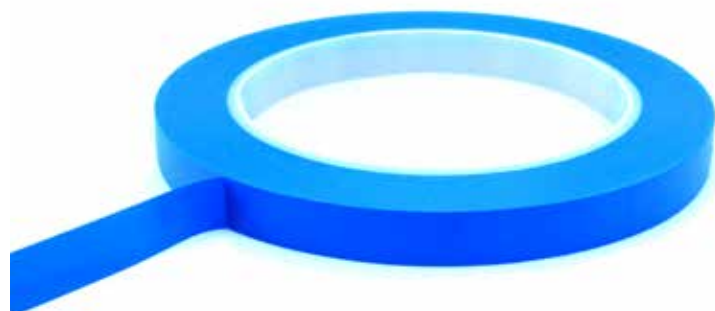

SERVIZIO DI TAGLIO NASTRO CON MISURE A RICHIESTA. ALTEZZE DISPONIBILI DA 3 A 1200mm CON PASSO 1 mm  
BESPOKEN THICKNESS CUT SERVICE. SIZE BETWEEN 3 TO 1200mm, STEP BY 1 mm



### Nastro Fine Line Tape

Nastro in pvc con adesivo in gomma. Resistente al calore fino a 155°C. Indicato per lavorazioni complesse per la sua conformabilità.



### High Temperature Fine Line Tape

PVC film with rubber adhesive, high conformability and a smooth, sharp mask-off edge. The blended rubber based adhesive system offers high temperature resistance up to 155°C.

Prezzo  
Price  
**0,833/mm**

## RPT

66mts

**SCONTO 20%**  
acquisto box completo

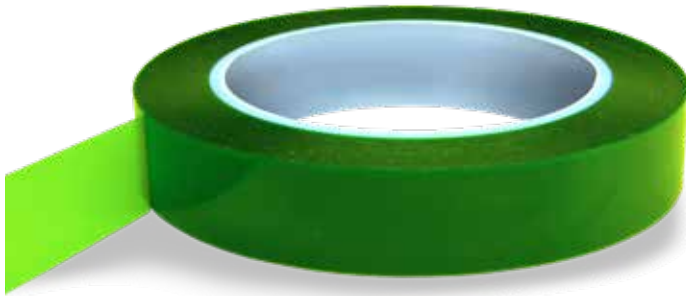

SERVIZIO DI TAGLIO NASTRO CON MISURE A RICHIESTA. ALTEZZE DISPONIBILI DA 3 A 1105 mm CON PASSO 1 mm  
BESPOKEN THICKNESS CUT SERVICE. SIZE BETWEEN 3 TO 1105 mm, STEP BY 1 mm

IT

**Nastro verde 190 °C. - SENZA SILICONE**  
Per rivestimenti a polvere e applicazioni di anodizzazione. Una volta rimosso lascia una superficie pulita, senza residui. 0,05 mm di poliestere - 0,04 mm di adesivo in gomma.



**Green tape 190 °C. - SILICONE FREE**  
Recommended for powder coating and anodizing applications. Clean removal, no adhesive residue.  
0,05mm polyester - 0,04mm rubber adhesive

Prezzo  
Price  
**0,740/mm**

## LALL65

50mts

**SCONTO 20%**  
acquisto box completo



SERVIZIO DI TAGLIO NASTRO CON MISURE A RICHIESTA. ALTEZZE DISPONIBILI DA 10 A 400 mm CON PASSO 1 mm  
BESPOKEN THICKNESS CUT SERVICE. SIZE BETWEEN 10 TO 400 mm, STEP BY 1 mm

IT

**Nastro in alluminio**  
Spessore 65µ. Accoppiato con liner in carta. Con adesivo acrilico ad alte prestazioni. Indicato per applicazioni elettriche e termiche. Ottima resistenza alla fiammatura.



**Aluminium tape**  
65µ tape Aluminium. coupled with paper liner. With high performance's acrylic adhesive. Particularly suitable for electrical and thermal applications. Good flame hardening resistant.

Prezzo  
Price  
**0,602/mm**

## LALL70

100mts

**SCONTO 20%**  
acquisto box completo



SERVIZIO DI TAGLIO NASTRO CON MISURE A RICHIESTA. ALTEZZE DISPONIBILI DA 10 A 1270 mm CON PASSO 1 mm  
BESPOKEN THICKNESS CUT SERVICE. SIZE BETWEEN 10 TO 1270 mm, STEP BY 1 mm

IT

**Nastro in alluminio laminato PET**  
Spessore 70µ. Nastro laminato PET con adesivo acrilico ad alte prestazioni. Indicato per applicazioni elettriche e termiche.



**Aluminium tape PET laminated**  
70µ tape Aluminium. PET laminated with acrylic adhesive with high performance. Particularly suitable for electrical and thermal applications.

Prezzo  
Price  
**1,326/mm**



# WE SOLVE EVERY MASKING PROBLEM

## SPG

50mts

**SCONTO 20%**  
acquisto box completo



SERVIZIO DI TAGLIO NASTRO CON MISURE A RICHIESTA. ALTEZZE DISPONIBILI DA 3 A 1230 mm CON PASSO 1 mm  
BESPOKEN THICKNESS CUT SERVICE. SIZE BETWEEN 3 TO 1230 mm, STEP BY 1 mm



**Nastro in carta alta temperatura 190 °C.**  
Indicato per verniciatura a polvere.  
Lascia una superficie pulita senza residui.  
Adesivo siliconico.



**High temperature masking tape 190 °C.**  
Recommended for powder coating.  
Clean removal. Silicone Adhesive.

Prezzo  
Price  
**0,968/mm**

## EPG

50mts

**SCONTO 20%**  
acquisto box completo



SERVIZIO DI TAGLIO NASTRO CON MISURE A RICHIESTA. ALTEZZE DISPONIBILI DA 3 A 1550 mm CON PASSO 1 mm  
BESPOKEN THICKNESS CUT SERVICE. SIZE BETWEEN 3 TO 1550 mm, STEP BY 1 mm



**Nastro per mascheratura 140 °C.**  
Indicato per verniciatura a liquido, lascia una  
superficie pulita senza residui.



**Masking tape 140 °C.**  
Recommended for painting. Clean removal.

Prezzo  
Price  
**0,519/mm**

## LPG

50mts

**SCONTO 20%**  
acquisto box completo



SERVIZIO DI TAGLIO NASTRO CON MISURE A RICHIESTA. ALTEZZE DISPONIBILI DA 3 A 1410 mm CON PASSO 1 mm  
BESPOKEN THICKNESS CUT SERVICE. SIZE BETWEEN 3 TO 1410 mm, STEP BY 1 mm



**Nastro in carta per mascheratura 80°C.**  
Indicato per verniciatura a liquido a  
bassa temperatura, lascia la superficie  
pulita senza residui.



**Semi creped paper masking tape 80°C.**  
Recommended for liquid coating at low  
temperature. Good adhesion on irregular  
surfaces and no adhesive residual.

Prezzo  
Price  
**0,116/mm**

## EPCL



Bollino adesivo con linguetta 204 °C.



Adhesive discs with tab 204 °C.



| CODICE CODE | DIAM. mm<br>DIAM mm | PZ ROLL<br>PCS. ROLL | €/ROT.<br>€/ROLL | € 10 ROT. (CAD.)<br>€ 10 ROLLS (EACH) |
|-------------|---------------------|----------------------|------------------|---------------------------------------|
| EPCL10      | 10                  | 2000                 | 44,64            | 35,71                                 |
| EPCL12      | 12                  | 2000                 | 53,56            | 42,85                                 |
| EPCL15      | 15                  | 2000                 | 73,04            | 58,43                                 |
| EPCL20      | 20                  | 1000                 | 54,79            | 43,83                                 |
| EPCL25      | 25                  | 500                  | 38,80            | 31,04                                 |
| EPCL30      | 30                  | 500                  | 51,03            | 40,82                                 |
| EPCL35      | 35                  | 500                  | 67,52            | 54,01                                 |
| EPCL40      | 40                  | 500                  | 83,86            | 67,09                                 |
| EPCL45      | 45                  | 500                  | 99,90            | 79,92                                 |
| EPCL50      | 50                  | 250                  | 59,35            | 47,47                                 |
| EPCL60      | 60                  | 250                  | 80,56            | 64,45                                 |
| EPCL70      | 70                  | 250                  | 103,47           | 82,78                                 |

REALIZZAZIONE BOLLINI CON DIAMETRI A RICHIESTA

## QPL



Quadrati in nastro verde 204 °C.



Squares green tape 204 °C.

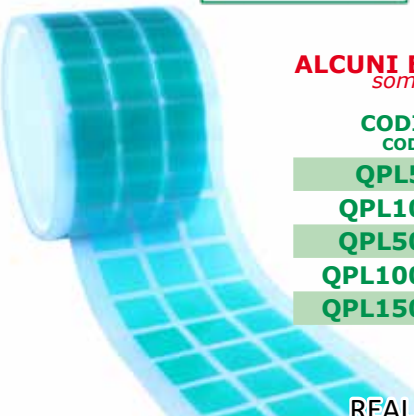

**ALCUNI ESEMPI**  
*some examples*

| CODICE CODE | DIAM. mm<br>DIAM mm | PZ ROLL<br>PCS. ROLL | €/ROT.<br>€/ROLL | € 10 ROT. (CAD.)<br>€ 10 ROLLS (EACH) |
|-------------|---------------------|----------------------|------------------|---------------------------------------|
| QPL5x5      | 5x5                 | 1000                 | 6,83             | 5,47                                  |
| QPL10x10    | 10x10               | 1000                 | 12,69            | 10,15                                 |
| QPL50x50    | 50x50               | 1000                 | 147,05           | 117,65                                |
| QPL100x100  | 100x100             | 250                  | 94,60            | 75,68                                 |
| QPL150x150  | 150x150             | 100                  | 79,79            | 63,84                                 |

REALIZZAZIONE QUADRATI ADESIVI CON MISURE A RICHIESTA FINO A LATO 500mm

## RPL



Rettangoli in nastro verde 204 °C.



Rectangles green tape 204 °C.



**ALCUNI ESEMPI**  
*some examples*

| CODICE CODE | DIAM. mm<br>DIAM mm | PZ ROLL<br>PCS. ROLL | €/ROT.<br>€/ROLL | € 10 ROT. (CAD.)<br>€ 10 ROLLS (EACH) |
|-------------|---------------------|----------------------|------------------|---------------------------------------|
| RPL5x10     | 5x10                | 1000                 | 9,52             | 7,61                                  |
| RPL10x50    | 10x50               | 1000                 | 48,84            | 39,08                                 |
| RPL25x100   | 25x100              | 1000                 | 155,42           | 124,33                                |
| RPL50x150   | 50x150              | 1000                 | 349,59           | 279,68                                |
| RPL100x200  | 100x200             | 100                  | 104,03           | 83,22                                 |

REALIZZAZIONE RETTANGOLI ADESIVI CON MISURE A RICHIESTA FINO A LATI 500x1000mm

# WE SOLVE EVERY MASKING PROBLEM

## EPC

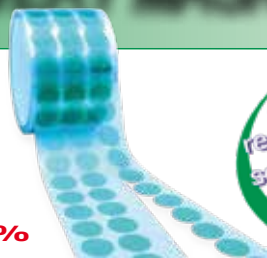

Altre dimensioni  
realizzabili a richiesta  
senza costi aggiuntivi  
Other sizes on demand  
with no additional cost



## CLD

10rolls - **SCONTO 20%**



**Dischi adesivi nastro verde 204 °C.**



**Green tape peel disks 204 °C.**

| Ø mm | PCS. ROLL | EPC €/ROLL | Ø mm | PCS. ROLL | EPC €/ROLL |
|------|-----------|------------|------|-----------|------------|
| 3    | 2000      | 8,70       | 55   | 250       | 42,62      |
| 4    | 2000      | 9,64       | 56   | 250       | 43,39      |
| 5    | 2000      | 12,82      | 57   | 250       | 44,17      |
| 6    | 2000      | 14,72      | 58   | 250       | 44,39      |
| 7    | 2000      | 17,37      | 59   | 250       | 45,10      |
| 8    | 2000      | 17,87      | 60   | 250       | 46,10      |
| 9    | 2000      | 22,46      | 61   | 250       | 46,28      |
| 10   | 2000      | 23,82      | 62   | 250       | 46,98      |
| 11   | 2000      | 27,05      | 63   | 250       | 48,41      |
| 12   | 2000      | 29,80      | 64   | 250       | 49,97      |
| 13   | 2000      | 32,75      | 65   | 250       | 50,80      |
| 14   | 2000      | 38,07      | 66   | 250       | 51,81      |
| 15   | 2000      | 40,79      | 67   | 250       | 53,15      |
| 16   | 2000      | 44,40      | 68   | 250       | 53,15      |
| 17   | 1000      | 24,52      | 69   | 250       | 53,28      |
| 18   | 1000      | 25,80      | 70   | 250       | 54,71      |
| 19   | 1000      | 27,08      | 71   | 250       | 55,09      |
| 20   | 1000      | 28,30      | 72   | 250       | 55,80      |
| 21   | 1000      | 29,58      | 73   | 250       | 56,58      |
| 22   | 500       | 18,36      | 74   | 250       | 58,12      |
| 23   | 500       | 19,03      | 75   | 250       | 58,12      |
| 24   | 500       | 20,40      | 76   | 250       | 61,92      |
| 25   | 500       | 22,58      | 77   | 250       | 63,05      |
| 26   | 500       | 23,67      | 78   | 250       | 63,55      |
| 27   | 500       | 24,76      | 79   | 250       | 67,82      |
| 28   | 500       | 24,86      | 80   | 250       | 67,98      |
| 29   | 500       | 25,28      | 81   | 250       | 69,43      |
| 30   | 500       | 25,68      | 82   | 250       | 69,68      |
| 31   | 500       | 31,92      | 83   | 250       | 70,53      |
| 32   | 500       | 31,70      | 84   | 250       | 71,85      |
| 33   | 500       | 34,36      | 85   | 250       | 72,23      |
| 34   | 500       | 36,94      | 86   | 250       | 70,28      |
| 35   | 500       | 38,27      | 87   | 250       | 60,26      |
| 36   | 500       | 48,70      | 88   | 250       | 77,02      |
| 37   | 500       | 40,73      | 89   | 250       | 77,90      |
| 38   | 500       | 49,46      | 90   | 250       | 78,77      |
| 39   | 500       | 49,46      | 91   | 250       | 81,19      |
| 40   | 500       | 50,76      | 92   | 250       | 82,04      |
| 41   | 500       | 53,29      | 93   | 250       | 82,88      |
| 42   | 500       | 56,12      | 94   | 250       | 83,73      |
| 43   | 500       | 54,57      | 95   | 250       | 84,87      |
| 44   | 500       | 60,12      | 96   | 250       | 87,20      |
| 45   | 500       | 61,49      | 97   | 250       | 88,05      |
| 46   | 250       | 32,02      | 98   | 250       | 90,96      |
| 47   | 250       | 33,93      | 99   | 250       | 89,80      |
| 48   | 250       | 35,33      | 100  | 250       | 90,96      |
| 49   | 250       | 28,53      | 150  | 100       | 47,14      |
| 50   | 250       | 36,09      | 200  | 100       | 95,11      |
| 51   | 250       | 38,85      | 300  | 100       | 206,37     |
| 52   | 250       | 39,55      | 400  | 100       | 391,48     |
| 53   | 250       | 40,56      | 500  | 100       | 585,77     |
| 54   | 250       | 42,62      |      |           |            |

10rolls - **SCONTO 20%**



**Dischi adesivi trasparenti 204 °C.**



**Clear tape adhesive disks 204 °C.**

| Ø mm | PCS. ROLL | CLD €/ROLL | Ø mm | PCS. ROLL | CLD €/ROLL |
|------|-----------|------------|------|-----------|------------|
| 3    | 2000      | 8,93       | 55   | 250       | 48,72      |
| 4    | 2000      | 11,48      | 56   | 250       | 49,53      |
| 5    | 2000      | 12,76      | 57   | 250       | 50,35      |
| 6    | 2000      | 16,38      | 58   | 250       | 51,15      |
| 7    | 2000      | 21,43      | 59   | 250       | 51,96      |
| 8    | 2000      | 23,23      | 60   | 250       | 59,38      |
| 9    | 2000      | 25,01      | 61   | 250       | 60,29      |
| 10   | 2000      | 33,50      | 62   | 250       | 61,20      |
| 11   | 2000      | 35,73      | 63   | 250       | 62,12      |
| 12   | 2000      | 37,96      | 64   | 250       | 63,03      |
| 13   | 2000      | 53,59      | 65   | 250       | 63,94      |
| 14   | 2000      | 56,57      | 66   | 250       | 64,86      |
| 15   | 2000      | 59,54      | 67   | 250       | 65,77      |
| 16   | 2000      | 51,15      | 68   | 250       | 66,68      |
| 17   | 1000      | 26,79      | 69   | 250       | 67,60      |
| 18   | 1000      | 35,02      | 70   | 250       | 73,08      |
| 19   | 1000      | 36,53      | 71   | 250       | 74,05      |
| 20   | 1000      | 38,06      | 72   | 250       | 75,03      |
| 21   | 1000      | 39,58      | 73   | 250       | 76,00      |
| 22   | 500       | 20,55      | 74   | 250       | 76,97      |
| 23   | 500       | 28,42      | 75   | 250       | 77,95      |
| 24   | 500       | 29,44      | 76   | 250       | 78,92      |
| 25   | 500       | 30,45      | 77   | 250       | 79,90      |
| 26   | 500       | 31,47      | 78   | 250       | 80,88      |
| 27   | 500       | 32,48      | 79   | 250       | 81,84      |
| 28   | 500       | 33,50      | 80   | 250       | 82,82      |
| 29   | 500       | 34,51      | 81   | 250       | 83,79      |
| 30   | 500       | 35,52      | 82   | 250       | 84,77      |
| 31   | 500       | 36,53      | 83   | 250       | 85,75      |
| 32   | 500       | 37,55      | 84   | 250       | 86,72      |
| 33   | 500       | 38,56      | 85   | 250       | 87,69      |
| 34   | 500       | 47,50      | 86   | 250       | 88,66      |
| 35   | 500       | 48,72      | 87   | 250       | 89,64      |
| 36   | 500       | 49,93      | 88   | 250       | 90,62      |
| 37   | 500       | 51,15      | 89   | 250       | 91,59      |
| 38   | 500       | 52,38      | 90   | 250       | 107,99     |
| 39   | 500       | 53,59      | 91   | 250       | 109,13     |
| 40   | 500       | 54,81      | 92   | 250       | 110,26     |
| 41   | 500       | 65,36      | 93   | 250       | 111,40     |
| 42   | 500       | 66,79      | 94   | 250       | 112,54     |
| 43   | 500       | 68,21      | 95   | 250       | 113,67     |
| 44   | 500       | 69,63      | 96   | 250       | 114,81     |
| 45   | 500       | 71,05      | 97   | 250       | 115,95     |
| 46   | 250       | 36,24      | 98   | 250       | 117,08     |
| 47   | 250       | 36,95      | 99   | 250       | 118,22     |
| 48   | 250       | 37,66      | 100  | 250       | 119,36     |
| 49   | 250       | 38,37      | 150  | 100       | 89,90      |
| 50   | 250       | 41,87      | 200  | 100       | 142,68     |
| 51   | 250       | 42,63      | 300  | 100       | 288,93     |
| 52   | 250       | 43,39      | 400  | 100       | 493,27     |
| 53   | 250       | 44,15      | 500  | 100       | 751,74     |
| 54   | 250       | 44,91      |      |           |            |



# EUROMASK®

## BPC



Altre dimensioni  
realizzabili a richiesta  
senza costi aggiuntivi  
Other sizes on demand  
with no additional cost



## EBC

10rolls - **SCONTO 20%**

 **Dischi adesivi polimide 260 °C.**

 **Polyimide peel disks 260 °C.**

| Ø mm | PCS. ROLL | BPC €/ROLL | Ø mm | PCS. ROLL | BPC €/ROLL |
|------|-----------|------------|------|-----------|------------|
| 3    | 2000      | 9,92       | 55   | 250       | 54,13      |
| 4    | 2000      | 12,76      | 56   | 250       | 55,03      |
| 5    | 2000      | 14,17      | 57   | 250       | 55,94      |
| 6    | 2000      | 18,19      | 58   | 250       | 56,84      |
| 7    | 2000      | 23,81      | 59   | 250       | 57,74      |
| 8    | 2000      | 25,80      | 60   | 250       | 65,97      |
| 9    | 2000      | 27,79      | 61   | 250       | 66,99      |
| 10   | 2000      | 37,21      | 62   | 250       | 68,00      |
| 11   | 2000      | 39,70      | 63   | 250       | 69,02      |
| 12   | 2000      | 42,18      | 64   | 250       | 70,03      |
| 13   | 2000      | 59,54      | 65   | 250       | 71,05      |
| 14   | 2000      | 62,85      | 66   | 250       | 72,06      |
| 15   | 2000      | 66,16      | 67   | 250       | 73,08      |
| 16   | 2000      | 56,84      | 68   | 250       | 74,09      |
| 17   | 1000      | 29,77      | 69   | 250       | 75,11      |
| 18   | 1000      | 38,90      | 70   | 250       | 101,50     |
| 19   | 1000      | 40,60      | 71   | 250       | 102,85     |
| 20   | 1000      | 42,29      | 72   | 250       | 104,21     |
| 21   | 1000      | 43,98      | 73   | 250       | 105,55     |
| 22   | 500       | 22,84      | 74   | 250       | 106,90     |
| 23   | 500       | 31,58      | 75   | 250       | 108,26     |
| 24   | 500       | 32,70      | 76   | 250       | 109,61     |
| 25   | 500       | 33,84      | 77   | 250       | 110,97     |
| 26   | 500       | 34,96      | 78   | 250       | 112,32     |
| 27   | 500       | 36,09      | 79   | 250       | 113,67     |
| 28   | 500       | 37,21      | 80   | 250       | 115,03     |
| 29   | 500       | 38,35      | 81   | 250       | 116,38     |
| 30   | 500       | 39,47      | 82   | 250       | 117,73     |
| 31   | 500       | 40,60      | 83   | 250       | 119,09     |
| 32   | 500       | 41,73      | 84   | 250       | 120,44     |
| 33   | 500       | 42,86      | 85   | 250       | 121,80     |
| 34   | 500       | 52,78      | 86   | 250       | 123,15     |
| 35   | 500       | 54,13      | 87   | 250       | 124,50     |
| 36   | 500       | 55,49      | 88   | 250       | 125,86     |
| 37   | 500       | 56,84      | 89   | 250       | 127,21     |
| 38   | 500       | 58,20      | 90   | 250       | 149,99     |
| 39   | 500       | 59,54      | 91   | 250       | 151,56     |
| 40   | 500       | 60,89      | 92   | 250       | 153,14     |
| 41   | 500       | 72,63      | 93   | 250       | 154,73     |
| 42   | 500       | 74,20      | 94   | 250       | 156,30     |
| 43   | 500       | 75,79      | 95   | 250       | 157,88     |
| 44   | 500       | 77,36      | 96   | 250       | 159,45     |
| 45   | 500       | 78,94      | 97   | 250       | 161,04     |
| 46   | 250       | 40,26      | 98   | 250       | 162,62     |
| 47   | 250       | 41,05      | 99   | 250       | 164,19     |
| 48   | 250       | 41,84      | 100  | 250       | 165,78     |
| 49   | 250       | 42,63      | 150  | 100       | 139,83     |
| 50   | 250       | 46,51      | 200  | 100       | 221,93     |
| 51   | 250       | 47,36      | 300  | 100       | 481,54     |
| 52   | 250       | 48,21      | 400  | 100       | 822,10     |
| 53   | 250       | 49,06      | 500  | 100       | 1252,89    |
| 54   | 250       | 49,90      |      |           |            |

10rolls - **SCONTO 20%**

 **Dischi adesivi in nastro blu 204 °C.**

 **Blue ribbon adhesive disks 204 °C.**

| Ø mm | PCS. ROLL | EBC €/ROLL | Ø mm | PCS. ROLL | EBC €/ROLL |
|------|-----------|------------|------|-----------|------------|
| 3    | 2000      | 8,93       | 55   | 250       | 48,08      |
| 4    | 2000      | 11,17      | 56   | 250       | 48,87      |
| 5    | 2000      | 13,96      | 57   | 250       | 49,68      |
| 6    | 2000      | 17,54      | 58   | 250       | 50,48      |
| 7    | 2000      | 19,14      | 59   | 250       | 51,28      |
| 8    | 2000      | 24,19      | 60   | 250       | 58,60      |
| 9    | 2000      | 26,05      | 61   | 250       | 59,49      |
| 10   | 2000      | 33,50      | 62   | 250       | 60,40      |
| 11   | 2000      | 33,50      | 63   | 250       | 61,30      |
| 12   | 2000      | 35,59      | 64   | 250       | 62,20      |
| 13   | 2000      | 47,10      | 65   | 250       | 63,10      |
| 14   | 2000      | 49,72      | 66   | 250       | 64,00      |
| 15   | 2000      | 52,33      | 67   | 250       | 64,90      |
| 16   | 2000      | 59,95      | 68   | 250       | 65,81      |
| 17   | 1000      | 31,40      | 69   | 250       | 66,70      |
| 18   | 1000      | 32,83      | 70   | 250       | 85,63      |
| 19   | 1000      | 34,26      | 71   | 250       | 86,78      |
| 20   | 1000      | 35,68      | 72   | 250       | 87,92      |
| 21   | 1000      | 43,66      | 73   | 250       | 89,06      |
| 22   | 500       | 22,67      | 74   | 250       | 90,21      |
| 23   | 500       | 23,50      | 75   | 250       | 91,34      |
| 24   | 500       | 24,35      | 76   | 250       | 92,48      |
| 25   | 500       | 25,18      | 77   | 250       | 93,63      |
| 26   | 500       | 26,03      | 78   | 250       | 94,77      |
| 27   | 500       | 35,82      | 79   | 250       | 95,91      |
| 28   | 500       | 36,95      | 80   | 250       | 97,06      |
| 29   | 500       | 38,06      | 81   | 250       | 98,20      |
| 30   | 500       | 37,01      | 82   | 250       | 99,33      |
| 31   | 500       | 38,06      | 83   | 250       | 100,48     |
| 32   | 500       | 39,12      | 84   | 250       | 101,62     |
| 33   | 500       | 40,17      | 85   | 250       | 102,76     |
| 34   | 500       | 49,48      | 86   | 250       | 103,91     |
| 35   | 500       | 50,75      | 87   | 250       | 105,05     |
| 36   | 500       | 52,02      | 88   | 250       | 106,19     |
| 37   | 500       | 53,28      | 89   | 250       | 107,33     |
| 38   | 500       | 54,55      | 90   | 250       | 126,56     |
| 39   | 500       | 55,83      | 91   | 250       | 127,88     |
| 40   | 500       | 57,09      | 92   | 250       | 129,21     |
| 41   | 500       | 68,08      | 93   | 250       | 130,55     |
| 42   | 500       | 69,57      | 94   | 250       | 131,88     |
| 43   | 500       | 71,05      | 95   | 250       | 133,21     |
| 44   | 500       | 72,52      | 96   | 250       | 134,55     |
| 45   | 500       | 74,01      | 97   | 250       | 135,88     |
| 46   | 250       | 37,74      | 98   | 250       | 137,21     |
| 47   | 250       | 38,48      | 99   | 250       | 138,55     |
| 48   | 250       | 39,22      | 100  | 250       | 124,33     |
| 49   | 250       | 39,96      | 150  | 100       | 94,39      |
| 50   | 250       | 41,31      | 200  | 100       | 149,80     |
| 51   | 250       | 42,07      | 300  | 100       | 325,04     |
| 52   | 250       | 42,82      | 400  | 100       | 554,92     |
| 53   | 250       | 43,57      | 500  | 100       | 845,70     |
| 54   | 250       | 44,32      |      |           |            |

# WE SOLVE EVERY MASKING PROBLEM

## EBV



Altre dimensioni  
realizzabili a richiesta  
senza costi aggiuntivi  
Other sizes on demand  
with no additional cost



## ELT

10rolls - **SCONTO 20%**

 **Bollini adesivi in vinile 100° C**

 **Vinyl adhesive discs 100 °C.**

| Ø mm | PCS. ROLL | EBV €/ROLL | Ø mm | PCS. ROLL | EBV €/ROLL |
|------|-----------|------------|------|-----------|------------|
| 3    | 2000      | 2,24       | 55   | 250       | 12,17      |
| 4    | 2000      | 2,87       | 56   | 250       | 12,38      |
| 5    | 2000      | 3,19       | 57   | 250       | 12,59      |
| 6    | 2000      | 4,09       | 58   | 250       | 12,79      |
| 7    | 2000      | 5,36       | 59   | 250       | 12,99      |
| 8    | 2000      | 5,81       | 60   | 250       | 14,84      |
| 9    | 2000      | 6,25       | 61   | 250       | 15,07      |
| 10   | 2000      | 8,37       | 62   | 250       | 15,30      |
| 11   | 2000      | 8,93       | 63   | 250       | 15,53      |
| 12   | 2000      | 9,49       | 64   | 250       | 15,76      |
| 13   | 2000      | 13,40      | 65   | 250       | 15,99      |
| 14   | 2000      | 14,14      | 66   | 250       | 16,21      |
| 15   | 2000      | 14,88      | 67   | 250       | 16,44      |
| 16   | 2000      | 12,79      | 68   | 250       | 16,67      |
| 17   | 1000      | 6,70       | 69   | 250       | 16,90      |
| 18   | 1000      | 8,76       | 70   | 250       | 22,84      |
| 19   | 1000      | 9,14       | 71   | 250       | 23,14      |
| 20   | 1000      | 9,52       | 72   | 250       | 23,44      |
| 21   | 1000      | 9,90       | 73   | 250       | 23,75      |
| 22   | 500       | 5,14       | 74   | 250       | 24,05      |
| 23   | 500       | 7,11       | 75   | 250       | 24,36      |
| 24   | 500       | 7,35       | 76   | 250       | 24,66      |
| 25   | 500       | 7,61       | 77   | 250       | 24,97      |
| 26   | 500       | 7,87       | 78   | 250       | 25,28      |
| 27   | 500       | 8,12       | 79   | 250       | 25,57      |
| 28   | 500       | 8,37       | 80   | 250       | 25,88      |
| 29   | 500       | 8,63       | 81   | 250       | 26,18      |
| 30   | 500       | 8,88       | 82   | 250       | 26,49      |
| 31   | 500       | 9,14       | 83   | 250       | 26,79      |
| 32   | 500       | 9,38       | 84   | 250       | 27,10      |
| 33   | 500       | 9,64       | 85   | 250       | 27,41      |
| 34   | 500       | 11,88      | 86   | 250       | 27,71      |
| 35   | 500       | 12,17      | 87   | 250       | 28,02      |
| 36   | 500       | 12,48      | 88   | 250       | 28,31      |
| 37   | 500       | 12,79      | 89   | 250       | 28,62      |
| 38   | 500       | 13,09      | 90   | 250       | 33,74      |
| 39   | 500       | 13,40      | 91   | 250       | 34,10      |
| 40   | 500       | 13,70      | 92   | 250       | 34,45      |
| 41   | 500       | 16,34      | 93   | 250       | 34,81      |
| 42   | 500       | 16,70      | 94   | 250       | 35,16      |
| 43   | 500       | 17,05      | 95   | 250       | 35,52      |
| 44   | 500       | 17,41      | 96   | 250       | 35,87      |
| 45   | 500       | 17,76      | 97   | 250       | 36,24      |
| 46   | 250       | 9,05       | 98   | 250       | 36,59      |
| 47   | 250       | 9,24       | 99   | 250       | 36,95      |
| 48   | 250       | 9,41       | 100  | 250       | 37,30      |
| 49   | 250       | 9,59       | 150  | 100       | 31,47      |
| 50   | 250       | 10,46      | 200  | 100       | 49,93      |
| 51   | 250       | 10,66      | 300  | 100       | 108,35     |
| 52   | 250       | 10,85      | 400  | 100       | 184,98     |
| 53   | 250       | 11,04      | 500  | 100       | 281,90     |
| 54   | 250       | 11,23      |      |           |            |

10rolls - **SCONTO 20%**

 **Bollini adesivi in carta 80 °C.**

 **Semi craped paper discs 80 °C.**

| Ø mm | PCS. ROLL | ELT €/ROLL | Ø mm | PCS. ROLL | ELT €/ROLL |
|------|-----------|------------|------|-----------|------------|
| 3    | 2000      | 2,73       | 55   | 250       | 14,88      |
| 4    | 2000      | 3,51       | 56   | 250       | 15,13      |
| 5    | 2000      | 3,90       | 57   | 250       | 15,38      |
| 6    | 2000      | 5,01       | 58   | 250       | 15,63      |
| 7    | 2000      | 6,55       | 59   | 250       | 15,88      |
| 8    | 2000      | 7,10       | 60   | 250       | 18,14      |
| 9    | 2000      | 7,64       | 61   | 250       | 18,42      |
| 10   | 2000      | 10,24      | 62   | 250       | 18,70      |
| 11   | 2000      | 10,92      | 63   | 250       | 18,98      |
| 12   | 2000      | 11,60      | 64   | 250       | 19,26      |
| 13   | 2000      | 16,38      | 65   | 250       | 19,54      |
| 14   | 2000      | 17,28      | 66   | 250       | 19,82      |
| 15   | 2000      | 18,19      | 67   | 250       | 20,10      |
| 16   | 2000      | 15,63      | 68   | 250       | 20,37      |
| 17   | 1000      | 8,19       | 69   | 250       | 20,65      |
| 18   | 1000      | 10,70      | 70   | 250       | 27,91      |
| 19   | 1000      | 11,17      | 71   | 250       | 28,28      |
| 20   | 1000      | 11,63      | 72   | 250       | 28,65      |
| 21   | 1000      | 12,09      | 73   | 250       | 29,03      |
| 22   | 500       | 6,28       | 74   | 250       | 29,40      |
| 23   | 500       | 8,68       | 75   | 250       | 29,77      |
| 24   | 500       | 8,99       | 76   | 250       | 30,15      |
| 25   | 500       | 9,30       | 77   | 250       | 30,52      |
| 26   | 500       | 9,61       | 78   | 250       | 30,89      |
| 27   | 500       | 9,92       | 79   | 250       | 31,26      |
| 28   | 500       | 10,24      | 80   | 250       | 31,63      |
| 29   | 500       | 10,55      | 81   | 250       | 32,00      |
| 30   | 500       | 10,86      | 82   | 250       | 32,37      |
| 31   | 500       | 11,17      | 83   | 250       | 32,75      |
| 32   | 500       | 11,47      | 84   | 250       | 33,12      |
| 33   | 500       | 11,78      | 85   | 250       | 33,50      |
| 34   | 500       | 14,51      | 86   | 250       | 33,87      |
| 35   | 500       | 14,88      | 87   | 250       | 34,24      |
| 36   | 500       | 15,25      | 88   | 250       | 34,61      |
| 37   | 500       | 15,63      | 89   | 250       | 34,98      |
| 38   | 500       | 16,01      | 90   | 250       | 41,24      |
| 39   | 500       | 16,38      | 91   | 250       | 41,68      |
| 40   | 500       | 16,75      | 92   | 250       | 42,12      |
| 41   | 500       | 19,97      | 93   | 250       | 42,55      |
| 42   | 500       | 20,40      | 94   | 250       | 42,98      |
| 43   | 500       | 20,84      | 95   | 250       | 43,41      |
| 44   | 500       | 21,27      | 96   | 250       | 43,85      |
| 45   | 500       | 21,71      | 97   | 250       | 44,29      |
| 46   | 250       | 11,07      | 98   | 250       | 44,72      |
| 47   | 250       | 11,29      | 99   | 250       | 45,16      |
| 48   | 250       | 11,51      | 100  | 250       | 45,59      |
| 49   | 250       | 11,72      | 150  | 100       | 38,46      |
| 50   | 250       | 12,79      | 200  | 100       | 61,03      |
| 51   | 250       | 13,03      | 300  | 100       | 132,43     |
| 52   | 250       | 13,26      | 400  | 100       | 251,20     |
| 53   | 250       | 13,49      | 500  | 100       | 375,87     |
| 54   | 250       | 13,72      |      |           |            |

## Fustellati Speciali

Engineered Die-Cut



### Fustellature di precisione.

Produzione di grossi o piccoli volumi.  
Vasta gamma di materiali.  
Rapidità di approntamento.  
Bassi costi di realizzazione impianto.



### Engineered precision tape die-cut.

Low or high volume quantities.  
Wide variety of materials.  
Fast turnaround.  
Very reasonable tooling costs.

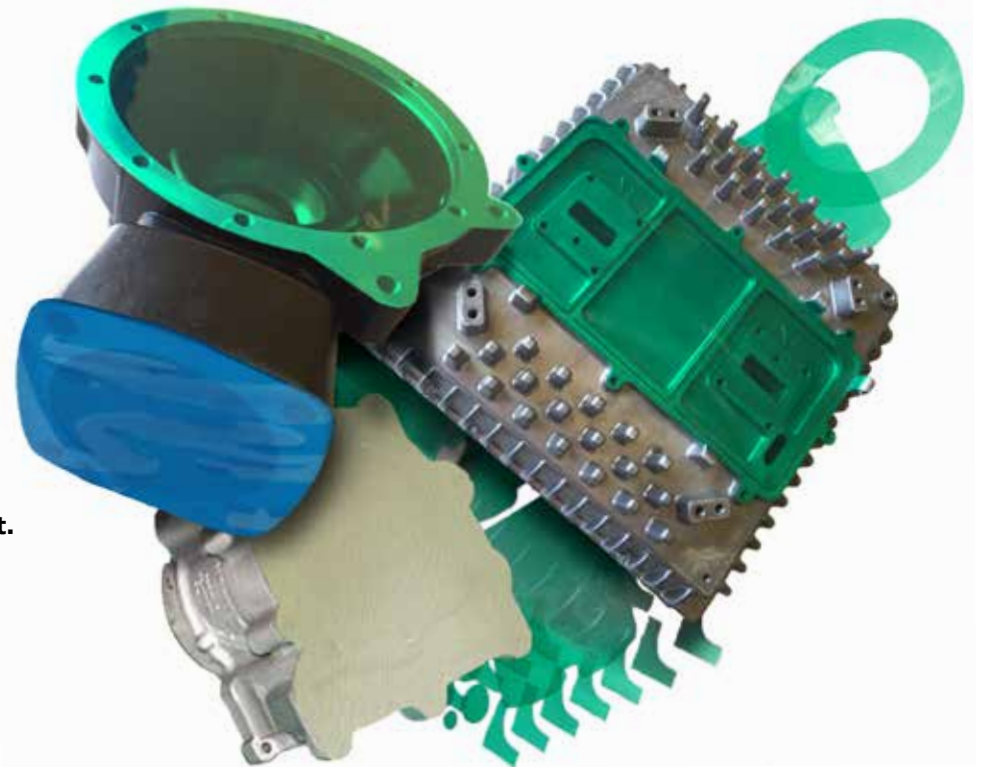

## Stampati Speciali

Engineered Molded



### Tappi e Cappucci stampati speciali.

Ampia varietà di materiali.  
Fornitura di campioni per l'approvazione del cliente prima di avviare la produzione. Nel reparto tecnico di Euromask® lavorano persone esperte; tecnici capaci di disegnare, modellare e realizzare prototipi con velocità e precisione.

Con Euromask®:

- Studio del prototipo da disegno 2D/3D o direttamente dal pezzo.
- Bassissimi costi per la Fornitura dei campioni: tappi o cappucci per la verniciatura ed altri trattamenti superficiali.

### Questo in 3 giorni, per geometrie molto complesse 5.

Quando il Cliente approva, immediata messa in produzione.  
Produciamo in proprio con tecnologie ed impianti moderni ed efficienti. Per i nostri Clienti questo significa costi contenuti e rapidità nella fornitura di grossi e piccoli quantitativi, in una vasta gamma di materiali.



### Engineered molded plugs and caps.

Wide variety of materials. Samples always provided for your approval before production. Skilled persons work in Euromask®'s department; technical experts able to draw, model and realize samples with precision and rapidity. With Euromask®:

- Prototype analysis starting from 2D or 3D drawing, or directly from the item that need to be masked
- Low prototypes supply costs: plugs or caps for painting operations and other surface treatments.

### This within 3 days, for more complex structures 5 days.

When the customer approves, immediate production.  
We produce directly on our own with modern and efficient technologies and plants. For our customers this means low prices and fast supply of large and small quantity of goods, with a wide range of materials available.





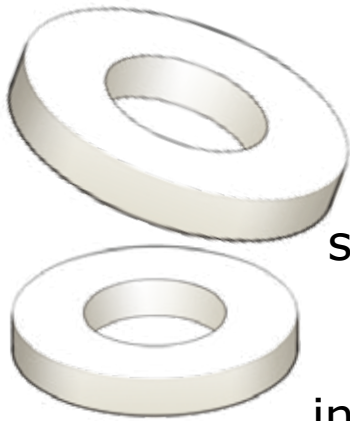

## Taglio Piano

Lavorazioni standard e a disegno su lastre da 2 a 15mm di spessore in silicone, EPDM, schiume a varia densità e materiali accoppiati.

Rapidità di campionatura e di produzione in 2/3 giorni in funzione della complessità delle sagome. Le forme realizzate soddisfano sia esigenze di trattamenti a polvere che a liquido creando sagome precise alla richiesta del cliente.

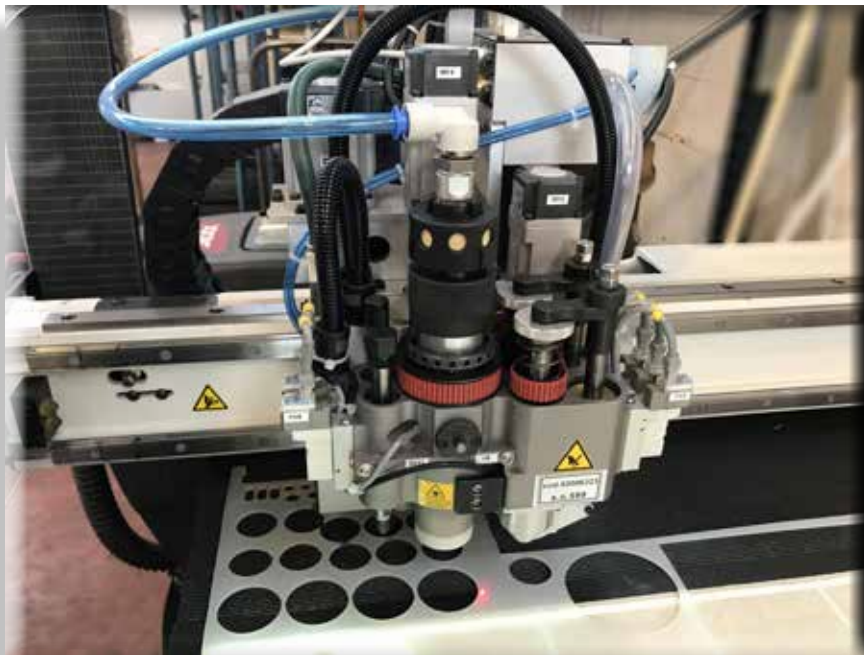

## Taglio Piano Speciali

Knife-Cutting Shapes



## Knife Cutting

Suitable for standard and bespoke shapes on Silicone, EPDM, Foams and sheets with liner from 2 to 15mm thickness.

Fast sampling and production in 2/3 days, depending on shape. All the materials and shapes created on customer's request are suitable for all the surface treatment, from liquid to powder coatings.



## EST



### Tubo cavo per rivestimenti in polvere 315 °C.

Indicato per rivestimenti in polvere e rivestimenti elettrostatici per immersione liquida.



### Tubing for Powder Coating 315 °C.

Recommended for powder coating and E-coating.



| CODICE CODE | Ø d   | Ø D   | LUNGH. LENGTH | €/BOBINA €/COIL |
|-------------|-------|-------|---------------|-----------------|
| EST2        | 2 mm  | 4 mm  | 50 m          | 52,57           |
| EST3        | 3 mm  | 5 mm  | 50 m          | 61,23           |
| EST4        | 4 mm  | 6 mm  | 50 m          | 78,21           |
| EST5        | 5 mm  | 7 mm  | 50 m          | 87,73           |
| EST6        | 6 mm  | 8 mm  | 50 m          | 103,90          |
| EST8        | 8 mm  | 10 mm | 50 m          | 142,22          |
| EST10       | 10 mm | 12 mm | 50 m          | 150,10          |
| EST12       | 12 mm | 15 mm | 50 m          | 224,02          |
| EST14       | 14 mm | 16 mm | 25 m          | 103,55          |
| EST16       | 16 mm | 22 mm | 25 m          | 323,35          |
| EST18       | 18 mm | 22 mm | 20 m          | 164,96          |
| EST20       | 20 mm | 24 mm | 20 m          | 183,83          |
| EST25       | 25 mm | 33 mm | 15 m          | 358,00          |
| EST30       | 30 mm | 40 mm | 10 m          | 403,04          |

5 coils -20%

## ETO



### Cordoncino pieno flessibile per rivestimenti in polvere 315 °C.

Indicato per rivestimenti in polvere e rivestimenti elettrostatici per immersione liquida.



### Flexible Cord for Powder Coating 315 °C.

Recommended for powder coating and E-coating.



| CODICE CODE | Ø D   | LUNGH. LENGTH | €/BOBINA €/COIL |
|-------------|-------|---------------|-----------------|
| ETO3        | 3 mm  | 100 m         | 132,43          |
| ETO4        | 4 mm  | 100 m         | 164,80          |
| ETO5        | 5 mm  | 100 m         | 214,84          |
| ETO6        | 6 mm  | 50 m          | 285,48          |
| ETO7        | 7 mm  | 50 m          | 178,05          |
| ETO8        | 8 mm  | 50 m          | 233,97          |
| ETO9        | 9 mm  | 25 m          | 147,88          |
| ETO10       | 10 mm | 25 m          | 364,93          |
| ETO11       | 11 mm | 25 m          | 220,73          |
| ETO12       | 12 mm | 25 m          | 262,66          |
| ETO13       | 13 mm | 25 m          | 309,01          |
| ETO14       | 14 mm | 25 m          | 358,30          |
| ETO15       | 15 mm | 25 m          | 428,21          |
| ETO16       | 16 mm | 15 m          | 280,76          |
| ETO18       | 18 mm | 15 m          | 354,93          |
| ETO20       | 20 mm | 15 m          | 438,36          |

5 coils -20%

# WE SOLVE EVERY MASKING PROBLEM

## EZT



**Tubo a stella in silicone 315 °C.**

La sua forma permette di utilizzarlo per i vari diametri.



**Silicone star tube 315 °C.**

Its shape allows to use it for various diameters.

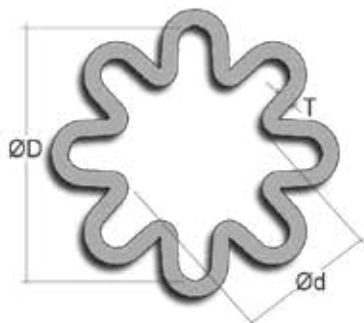

| CODICE CODE | Ød    | ØD    | T    | LUNGH. LENGTH | €/BOBINA €/COIL |
|-------------|-------|-------|------|---------------|-----------------|
| EZT3X5      | 2,80  | 5,30  | 1,52 | 30,48         | 121,86          |
| EZT5X7      | 4,80  | 7,30  | 1,52 | 30,48         | 157,34          |
| EZT6X6,5    | 5,08  | 6,35  | 1,52 | 30,48         | 140,47          |
| EZT7X9      | 6,50  | 9,50  | 1,52 | 30,48         | 196,32          |
| EZT8X9      | 7,62  | 9,53  | 1,52 | 30,48         | 196,74          |
| EZT9X11     | 8,50  | 11,50 | 1,52 | 30,48         | 231,73          |
| EZT10X12    | 10,16 | 12,70 | 1,52 | 30,48         | 253,00          |
| EZT11X13    | 10,70 | 14,00 | 1,52 | 30,48         | 276,02          |
| EZT13X17    | 12,50 | 18,00 | 1,52 | 30,48         | 346,83          |
| EZT13X15    | 12,70 | 15,88 | 1,52 | 30,48         | 309,19          |
| EZT15X18    | 15,88 | 19,05 | 1,52 | 15,24         | 183,27          |
| EZT19X22    | 18,42 | 22,23 | 1,52 | 15,24         | 211,37          |
| EZT22X25    | 21,59 | 25,40 | 1,52 | 15,24         | 239,54          |
| EZT25X30    | 25,40 | 31,75 | 1,52 | 7,62          | 148,45          |
| EZT32X38    | 31,75 | 38,10 | 1,52 | 7,62          | 176,54          |
| EZT38X44    | 38,10 | 44,45 | 1,52 | 7,62          | 204,63          |
| EZT44X50    | 44,45 | 50,80 | 1,52 | 7,62          | 232,80          |

5 coils -20%

## ASC



**Corda in schiuma di silicone tonda 220 °C.**



**Round silicone foam cord 220 °C.**

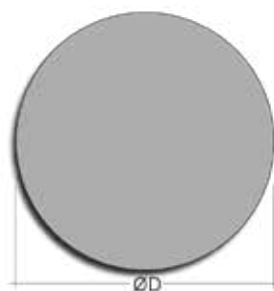

| CODICE CODE | DIAM. mm DIAM. mm | LUNGH. LENGTH | €/BOBINA €/COIL |
|-------------|-------------------|---------------|-----------------|
| ASC020      | 2 mm              | 25 m          | 11,88           |
| ASC030      | 3 mm              | 25 m          | 17,37           |
| ASC040      | 4 mm              | 25 m          | 27,73           |
| ASC050      | 5 mm              | 25 m          | 40,78           |
| ASC060      | 6 mm              | 25 m          | 56,63           |
| ASC070      | 7 mm              | 25 m          | 75,13           |
| ASC080      | 8 mm              | 25 m          | 96,38           |
| ASC090      | 9 mm              | 25 m          | 120,41          |
| ASC100      | 10 mm             | 25 m          | 147,11          |
| ASC120      | 12 mm             | 25 m          | 208,68          |
| ASC160      | 16 mm             | 25 m          | 364,61          |
| ASC180      | 18 mm             | 25 m          | 458,90          |
| ASC200      | 20 mm             | 25 m          | 564,12          |
| ASC250      | 25 mm             | 25 m          | 874,81          |
| ASC300      | 30 mm             | 25 m          | 1253,69         |

5 coils -20%

## QSC



**Corda in schiuma di silicone quadra 220 °C.**



**Square silicone foam cord 220 °C.**



| CODICE CODE | SEZIONE | LUNGH. LENGTH | €/BOBINA €/COIL |
|-------------|---------|---------------|-----------------|
| QSC 10 X 10 | 10 mm   | 25 m          | 170,27          |
| QSC 12 X 12 | 12 mm   | 25 m          | 244,04          |
| QSC 20 X 20 | 20 mm   | 25 m          | 673,44          |

5 coils -20%



## TMF



Tappi multi-flangia in Silicone per fori di diversi diametri.



Silicone multi-flange plugs suitable for different diameters

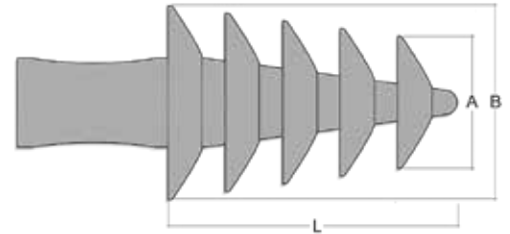

| CODICE CODE | A     | B     | L     | PZ CONF. PCS. BOX | € / CONF € / BOX |
|-------------|-------|-------|-------|-------------------|------------------|
| TMF4-10     | 4,00  | 10,00 | 13,60 | 500               | 97,74            |
| TMF8-16     | 8,00  | 16,00 | 23,50 | 200               | 102,54           |
| TMF10-18    | 10,00 | 18,00 | 24,00 | 200               | 155,31           |

FORME E DIMENSIONI PERSONALIZZATE REALIZZABILI SU RICHIESTA

5 boxes -20%

## DFPP



Tappo speciale per protezione dadi 315 °C



Special nut protection plug 315 °C

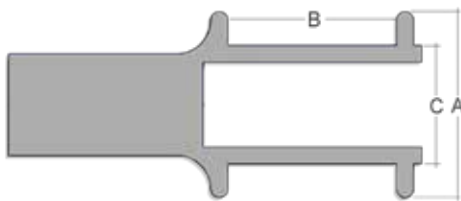

| CODICE CODE | A     | B     | C     | PZ CONF. PCS. BOX | €/CONF. €/BOX |
|-------------|-------|-------|-------|-------------------|---------------|
| DFPP05      | 5,40  | 3,00  | 4,10  | 500               | 24,75         |
| DFPP06      | 6,70  | 3,80  | 5,10  | 500               | 40,43         |
| DFPP08      | 8,70  | 5,35  | 6,70  | 500               | 82,45         |
| DFPP10      | 11,20 | 6,60  | 8,50  | 500               | 91,52         |
| DFPP12      | 13,00 | 6,60  | 10,10 | 250               | 75,08         |
| DFPP14      | 15,20 | 8,00  | 12,10 | 250               | 121,22        |
| DFPP16      | 16,60 | 9,30  | 13,90 | 100               | 81,13         |
| DFPP18      | 19,80 | 10,50 | 15,90 | 100               | 88,44         |
| DFPP20      | 21,01 | 12,30 | 17,80 | 100               | 128,15        |

FORME E DIMENSIONI PERSONALIZZATE REALIZZABILI SU RICHIESTA

## CSINK



Tappo speciale con flangia 315 °C



Countersink plugs 315 °C

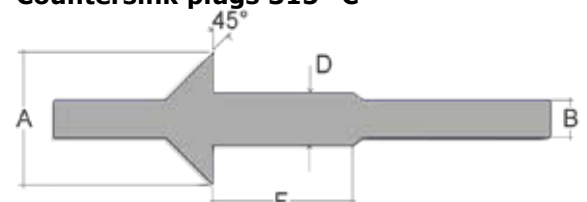

| CODICE CODE | A     | B    | D     | F     | PZ. CONF. PCS. BOX | €/CONF. €/BOX |
|-------------|-------|------|-------|-------|--------------------|---------------|
| CSINK030    | 10,00 | 2,50 | 2,90  | 15,00 | 100                | 28,60         |
| CSINK040    | 10,00 | 3,00 | 3,80  | 15,00 | 100                | 30,32         |
| CSINK045    | 12,00 | 3,00 | 4,50  | 15,00 | 100                | 31,57         |
| CSINK050    | 15,00 | 4,00 | 5,00  | 15,00 | 100                | 32,65         |
| CSINK060    | 14,00 | 4,00 | 5,50  | 15,00 | 100                | 35,38         |
| CSINK080    | 16,00 | 4,00 | 7,40  | 15,00 | 100                | 56,23         |
| CSINK100    | 18,00 | 5,00 | 9,20  | 15,00 | 100                | 69,04         |
| CSINK120    | 20,00 | 5,00 | 11,00 | 15,00 | 100                | 72,48         |
| CSINK140    | 20,00 | 6,00 | 13,46 | 15,00 | 100                | 74,69         |

FORME E DIMENSIONI PERSONALIZZATE REALIZZABILI SU RICHIESTA

5 boxes -20%

# WE SOLVE EVERY MASKING PROBLEM



## Tappi conici con maniglia 315 °C.

Indicato per rivestimenti in polvere, elettrostatici per immersione liquida e platinatura. Riutilizzabili.



## Silicone conical plugs with handle 315 °C.

Recommended for powder coating, E-coating and plating. Reusable.



# CPHS



| CODICE CODE | FORI HOLES | A     | B     | L     | PZ BOX PCS BOX | €/CONF. €/BOX |
|-------------|------------|-------|-------|-------|----------------|---------------|
| CPHS100     | 1-3        | 3,18  | 1,60  | 15,88 | 1000           | 65,04         |
| CPHS101     | 2-4        | 4,75  | 1,60  | 15,88 | 1000           | 68,19         |
| CPHS102     | 4-6        | 6,35  | 3,18  | 19,05 | 1000           | 106,02        |
| CPHS103     | 6-8        | 8,71  | 4,78  | 15,88 | 1000           | 139,49        |
| CPHS104     | 7-9        | 9,53  | 6,35  | 19,05 | 100            | 24,59         |
| CPHS000     | 9-10       | 11,91 | 8,74  | 20,65 | 100            | 33,91         |
| CPHS00      | 11-14      | 15,09 | 10,31 | 25,40 | 100            | 45,98         |
| CPHS0       | 14-16      | 16,66 | 12,70 | 25,40 | 100            | 65,63         |

FORME E DIMENSIONI PERSONALIZZATE REALIZZABILI SU RICHIESTA

5 boxes -20%



## Tappi copri-filetto 315 °C.



## Thread mask 315 °C.



# ETM

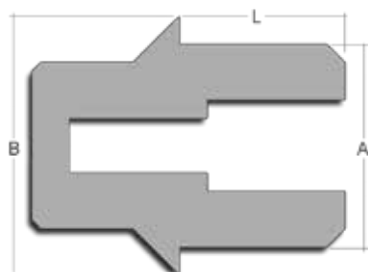

| CODICE CODE | A     | B     | L     | PZ CONF. PCS. BOX | €/CONF. €/BOX |
|-------------|-------|-------|-------|-------------------|---------------|
| ETM6        | 5,33  | 6,35  | 5,08  | 500               | 34,65         |
| ETM8        | 7,20  | 8,55  | 3,20  | 500               | 46,20         |
| ETM10       | 9,00  | 10,15 | 4,70  | 250               | 36,96         |
| ETM12       | 11,00 | 12,20 | 6,70  | 250               | 73,92         |
| ETM16       | 14,90 | 16,60 | 8,30  | 100               | 46,20         |
| ETM20       | 18,40 | 20,50 | 10,30 | 100               | 64,68         |

FORME E DIMENSIONI PERSONALIZZATE REALIZZABILI SU RICHIESTA

5 boxes -20%



## Tappo conico cavo con maniglia 315 °C.



## Hollow conical plug with handle 315 °C.

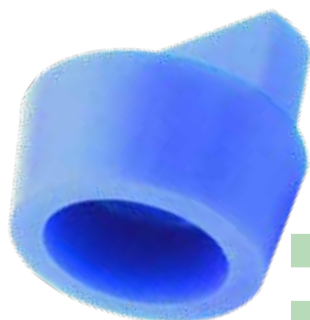

# MHEP

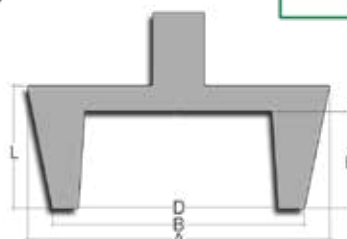

| CODICE CODE | A     | B     | L     | D     | E     | PZ CONF. PCS. BOX | €/CONF. €/BOX |
|-------------|-------|-------|-------|-------|-------|-------------------|---------------|
| MHEP5       | 27,00 | 23,01 | 25,40 | 10,31 | 19,05 | 100               | 210,35        |
| MHEP6       | 31,75 | 26,19 | 25,40 | 13,49 | 19,05 | 100               | 267,22        |
| MHEP7       | 36,50 | 30,15 | 25,40 | 17,45 | 19,05 | 10                | 40,63         |
| MHEP10      | 50,01 | 41,28 | 25,40 | 28,58 | 19,05 | 10                | 71,61         |
| MHEP11      | 55,96 | 47,63 | 25,40 | 34,93 | 19,05 | 1                 | 9,27          |

FORME E DIMENSIONI PERSONALIZZATE REALIZZABILI SU RICHIESTA

## WFP



### Tappi con rondella 315 °C.

Ideale per mascherare attorno ad un foro per la messa a terra. Duplice possibilità d'uso.



### Silicone Flange Plugs 315 °C.

Ideal for masking holes and the grounding area around them. Dual purpose plugs.



| CODICE CODE    | FORO HOLE | A     | B     | C     | D     | F     | G    | H     | PZ CONF. PCS BOX | €/CONF. €/BOX |
|----------------|-----------|-------|-------|-------|-------|-------|------|-------|------------------|---------------|
| WFP110-276-146 | M3        | 7,00  | 2,80  | 3,70  | 5,80  | 7,40  | 1,40 | 1,90  | 1000             | 49,79         |
| WFP142-354-195 | M4        | 9,00  | 3,60  | 4,70  | 7,20  | 9,40  | 1,80 | 2,40  | 1000             | 60,62         |
| WFP177-394-224 | M5        | 9,50  | 4,50  | 5,70  | 9,00  | 11,40 | 2,30 | 2,80  | 1000             | 78,80         |
| WFP289-492-264 | M6        | 12,50 | 5,30  | 6,70  | 10,60 | 13,40 | 2,60 | 3,40  | 500              | 133,35        |
| WFP280-669-343 | M8        | 17,00 | 7,10  | 8,70  | 14,20 | 17,40 | 3,60 | 4,30  | 500              | 164,93        |
| WFP375-500-455 | M10       | 12,70 | 9,52  | 11,55 | 12,70 | 12,70 | 7,20 | 9,90  | 250              | 108,90        |
| WFP375-787-512 | M10       | 20,00 | 9,53  | 13,00 | 12,70 | 12,70 | 7,20 | 10,00 | 250              | 117,23        |
| WFP378-827-421 | M10       | 21,00 | 9,60  | 10,70 | 19,20 | 21,40 | 4,80 | 5,40  | 250              | 118,17        |
| WFP429-945-500 | M12       | 24,00 | 10,90 | 12,70 | 21,80 | 25,40 | 5,50 | 6,40  | 250              | 153,05        |

FORME E DIMENSIONI PERSONALIZZATE REALIZZABILI SU RICHIESTA

## SP

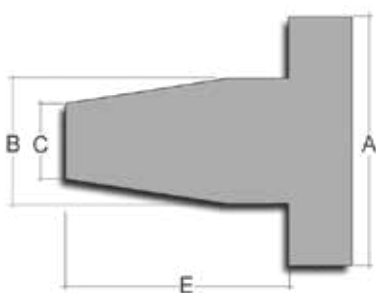

### Tappi a gradino 315 °C.

Indicati per rivestimenti in polvere, elettrostatici per immersione liquida, anodizzazione e platinatura. Assicura una zona pulita attorno al diametro del foro per la messa a terra.



### Step Plugs 315 °C.

Recommended for powder coating, E-coating, anodizing and plating.

Provides clean area around diameter of hole for earthing purpose.

| CODICE CODE | A     | B    | C    | E     | PZ CONF. PCS BOX | €/CONF. €/BOX |
|-------------|-------|------|------|-------|------------------|---------------|
| SP03        | 7,01  | 3,00 | 2,36 | 13,00 | 500              | 76,95         |
| SP04        | 8,00  | 5,00 | 2,84 | 14,00 | 500              | 82,98         |
| SP05        | 8,99  | 5,99 | 3,94 | 16,03 | 500              | 103,74        |
| SP06        | 10,16 | 6,43 | 4,78 | 17,63 | 250              | 67,50         |
| SP08        | 12,42 | 8,23 | 5,94 | 17,32 | 250              | 84,99         |

FORME E DIMENSIONI PERSONALIZZATE REALIZZABILI SU RICHIESTA

5 boxes -20%

## SKIT



### Starter kit.

| CODICE CODE | ARTICOLO ITEMS                                  | PREZZO CAD PRICE EACH |
|-------------|---|-----------------------|
| SKITSILI    | Starter kit tappi e cappucci in silicone 315 °C | € 50,00               |
| SKITEPDM    | Starter kit tappi e cappucci in E.P.D.M 177 °C  | € 45,00               |



# WE SOLVE EVERY MASKING PROBLEM



## Tappi senza flange 315 ° C.

Indicati per rivestimenti in polvere, elettrostatici per immersione liquida, platinatura e anodizzazione.

Fori filettati. Forma conica e interno cavo per molteplici applicazioni.

Proteggono i fori filettati senza mascherare la zona circostante.



## Flangeless Plugs 315 °C.

Recommended for powder coating, E-coating, plating and anodizing. Threaded holes.

Tapered design and hollow core for multi-applications.

Protect threaded holes without masking the surrounding area.

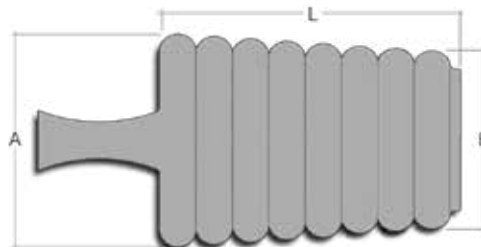

| CODICE CODE | A     | B     | L     | PZ. CONF. PCS. BOX | €/CONF. €/BOX |
|-------------|-------|-------|-------|--------------------|---------------|
| FP157       | 3,99  | 2,01  | 19,05 | 250                | 58,43         |
| FP250       | 5,99  | 3,99  | 25,40 | 250                | 74,66         |
| FP312       | 8,00  | 5,99  | 25,40 | 250                | 97,05         |
| FP394       | 10,01 | 8,00  | 25,40 | 250                | 98,89         |
| FP406       | 10,31 | 7,95  | 25,40 | 250                | 99,55         |
| FP468       | 11,89 | 10,31 | 25,40 | 250                | 112,02        |
| FP472       | 11,99 | 10,01 | 25,40 | 250                | 119,50        |
| FP551       | 14,00 | 11,99 | 25,40 | 250                | 122,49        |
| FP562       | 14,27 | 11,89 | 25,40 | 250                | 124,44        |
| FP625       | 15,88 | 14,27 | 25,40 | 250                | 137,03        |
| FP630       | 16,00 | 14,00 | 25,40 | 250                | 141,88        |
| FP709       | 18,01 | 16,00 | 25,40 | 250                | 145,92        |
| FP718       | 18,24 | 15,88 | 25,40 | 250                | 149,31        |
| FP750       | 19,05 | 18,24 | 25,40 | 100                | 64,77         |
| FP787       | 19,99 | 18,01 | 25,40 | 100                | 72,49         |
| FP866       | 22,23 | 19,05 | 25,40 | 100                | 74,84         |
| FP886       | 22,50 | 19,99 | 25,40 | 100                | 79,57         |
| FP945       | 24,00 | 22,50 | 25,40 | 100                | 85,79         |
| FP1000      | 25,40 | 22,23 | 25,40 | 100                | 89,71         |
| FP1024      | 26,01 | 24,00 | 25,40 | 100                | 98,18         |
| FP1102      | 27,99 | 26,01 | 25,40 | 100                | 105,46        |
| FP1125      | 28,58 | 25,40 | 25,40 | 100                | 109,89        |
| FP1250      | 31,75 | 28,58 | 25,40 | 100                | 124,49        |

5 boxes **-20%**

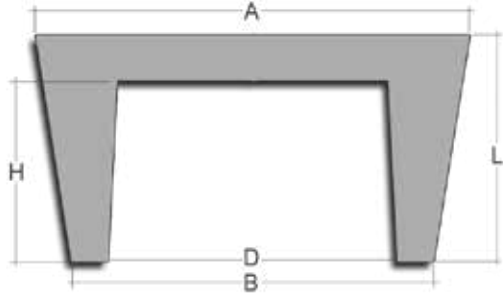

## HEP

### Tappi conici in silicone concavi 315 °C.

Indicato per rivestimenti in polvere, elettrostatici per immersione liquida e platinatura. Riutilizzabili.



### Hollow silicone plugs 315 °C.

Recommended for powder coating, E-coating and plating. Reusable.

| CODICE CODE | A      | B     | L     | D     | H     | PZ CONF. PCS BOX | €/CONF. €/BOX |
|-------------|--------|-------|-------|-------|-------|------------------|---------------|
| HEP5        | 27,00  | 23,01 | 25,40 | 12,50 | 19,05 | 100              | 131,47        |
| HEP5,5      | 27,94  | 24,00 | 25,40 | 13,00 | 19,05 | 100              | 163,71        |
| HEP6        | 32,00  | 26,19 | 25,40 | 15,50 | 19,05 | 100              | 167,08        |
| HEP6,5      | 33,99  | 27,00 | 25,40 | 17,00 | 19,05 | 100              | 179,41        |
| HEP7        | 36,53  | 30,18 | 25,40 | 17,48 | 19,05 | 10               | 25,40         |
| HEP7,5      | 38,99  | 30,99 | 25,40 | 21,80 | 19,05 | 10               | 27,82         |
| HEP8        | 41,28  | 33,35 | 25,40 | 20,65 | 19,05 | 10               | 28,14         |
| HEP8,5      | 43,00  | 35,99 | 25,40 | 26,00 | 19,05 | 10               | 28,74         |
| HEP9        | 44,45  | 37,31 | 25,40 | 24,61 | 19,05 | 10               | 29,35         |
| HEP9,5      | 45,97  | 38,00 | 25,40 | 25,30 | 19,05 | 10               | 43,55         |
| HEP10       | 49,99  | 41,99 | 25,40 | 31,60 | 19,05 | 10               | 44,76         |
| HEP10,5     | 52,98  | 44,96 | 25,40 | 32,26 | 19,05 | 10               | 48,39         |
| HEP11       | 55,96  | 48,01 | 25,40 | 35,31 | 19,05 | 1                | 5,80          |
| HEP11,5     | 62,71  | 50,01 | 25,40 | 30,96 | 15,88 | 1                | 7,93          |
| HEP12       | 63,50  | 53,98 | 25,40 | 34,93 | 15,88 | 1                | 8,17          |
| HEP13       | 68,28  | 57,94 | 25,40 | 38,89 | 15,88 | 1                | 10,52         |
| HEP13,5     | 75,01  | 61,93 | 34,93 | 42,88 | 25,40 | 1                | 15,72         |
| HEP13,78    | 81,99  | 68,00 | 38,10 | 42,60 | 25,40 | 1                | 16,92         |
| HEP14       | 88,90  | 76,20 | 38,10 | 50,80 | 25,40 | 1                | 18,14         |
| HEP15       | 101,60 | 82,55 | 38,10 | 57,15 | 25,40 | 1                | 31,94         |
| HEP16       | 127,00 | 88,90 | 50,80 | 78,00 | 30,00 | 1                | 52,11         |

5 boxes **-20%**



FORME E DIMENSIONI PERSONALIZZATE REALIZZABILI SU RICHIESTA

# WE SOLVE EVERY MASKING PROBLEM



## Tappi con maniglia di estrazione 315 °C

Per rivestimenti in polvere, elettrostatici per immersione liquida, anodizzazione e platinatura. Ideali per fori passanti.



## Pull Plug 315 °C

Recommended for powder coating, E-coating, anodizing and plating. Ideal for through holes.

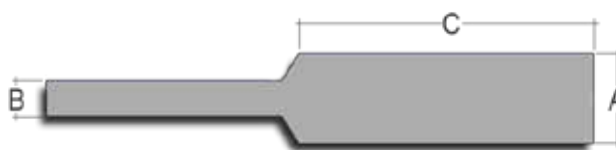

|  | CODICE CODE | A    | B    | C     | PCS BOX | €/BOX |
|--|-------------|------|------|-------|---------|-------|
|  | CPP06       | 1,57 | 1,02 | 12,70 | 500     | 17,25 |
|  | CPP07       | 1,70 | 1,19 | 15,88 | 500     | 18,35 |
|  | CPP08       | 1,85 | 1,17 | 15,54 | 500     | 21,69 |
|  | CPP09       | 2,31 | 1,32 | 15,88 | 500     | 22,22 |
|  | CPP10(2)    | 2,36 | 1,27 | 15,88 | 500     | 24,42 |
|  | CPP95-1000  | 2,41 | 1,32 | 25,40 | 500     | 31,79 |
|  | CPP10(A)    | 2,67 | 2,08 | 25,40 | 500     | 27,28 |
|  | CPP11       | 2,77 | 1,57 | 25,40 | 500     | 28,60 |
|  | CPP11B      | 3,00 | 2,08 | 25,40 | 500     | 39,44 |
|  | CPP11A(3)   | 3,18 | 1,57 | 15,88 | 500     | 39,88 |
|  | CPP15       | 3,30 | 2,36 | 15,88 | 500     | 40,76 |
|  | CPP14       | 3,30 | 2,36 | 25,40 | 500     | 35,37 |
|  | CPP17       | 3,56 | 2,16 | 15,88 | 500     | 35,15 |
|  | CPP18       | 3,91 | 1,57 | 15,88 | 500     | 34,78 |
|  | CPP20(4A)   | 3,96 | 1,57 | 15,88 | 500     | 37,53 |
|  | CPP21       | 4,01 | 2,08 | 31,75 | 500     | 39,14 |
|  | CPP22       | 4,11 | 2,44 | 15,88 | 500     | 42,41 |
|  | CPP23(4)    | 4,95 | 2,79 | 25,40 | 500     | 50,55 |
|  | CPP26       | 5,00 | 2,79 | 25,40 | 500     | 57,37 |
|  | CPP30       | 5,54 | 3,30 | 25,40 | 500     | 72,88 |
|  | CPP33       | 5,72 | 3,18 | 25,40 | 500     | 75,86 |
|  | CPP37(5)    | 6,53 | 3,30 | 25,40 | 500     | 83,55 |
|  | CPP40       | 6,99 | 3,18 | 23,80 | 500     | 86,88 |
|  | CPP42(6)    | 7,92 | 3,73 | 25,40 | 500     | 94,12 |

|  | CODICE CODE | A     | B     | C     | PCS BOX | €/BOX  |
|--|-------------|-------|-------|-------|---------|--------|
|  | CPP42       | 8,43  | 6,35  | 28,58 | 500     | 109,52 |
|  | CPP43       | 8,51  | 3,89  | 25,40 | 500     | 130,85 |
|  | CPP355-1000 | 9,02  | 3,99  | 25,40 | 500     | 165,04 |
|  | CPP50       | 9,53  | 3,99  | 25,40 | 500     | 131,95 |
|  | CPP55       | 9,75  | 3,91  | 25,40 | 250     | 69,61  |
|  | CPP55(7)    | 9,86  | 3,99  | 25,40 | 250     | 110,87 |
|  | CPP60       | 10,36 | 4,85  | 25,63 | 250     | 127,44 |
|  | CPP63       | 10,52 | 3,99  | 13,34 | 250     | 127,71 |
|  | CPP66       | 11,28 | 6,48  | 25,40 | 250     | 127,88 |
|  | CPP67       | 11,30 | 6,48  | 25,40 | 250     | 131,86 |
|  | CPP70       | 11,89 | 6,35  | 25,40 | 250     | 133,62 |
|  | CPP73       | 12,60 | 6,35  | 25,40 | 250     | 134,61 |
|  | CPP77       | 12,95 | 6,50  | 25,40 | 250     | 138,47 |
|  | CPP80       | 13,46 | 6,35  | 25,40 | 250     | 148,94 |
|  | CPP570-1000 | 14,48 | 7,92  | 25,40 | 100     | 91,23  |
|  | CPP87       | 15,54 | 6,35  | 25,40 | 100     | 96,17  |
|  | CPP88       | 15,75 | 8,36  | 38,10 | 100     | 156,30 |
|  | CPP90       | 16,26 | 9,53  | 25,40 | 100     | 86,22  |
|  | CPP95       | 17,78 | 9,53  | 31,75 | 100     | 127,11 |
|  | CPP100      | 19,56 | 9,53  | 25,40 | 100     | 128,32 |
|  | CPP809-1000 | 20,55 | 8,00  | 25,40 | 50      | 84,60  |
|  | CPP110(13)  | 22,76 | 9,53  | 25,40 | 50      | 61,44  |
|  | CPP120      | 25,91 | 9,53  | 25,40 | 50      | 92,26  |
|  | CPP130      | 35,05 | 12,70 | 25,40 | 50      | 258,43 |



FORME E DIMENSIONI PERSONALIZZATE REALIZZABILI SU RICHIESTA

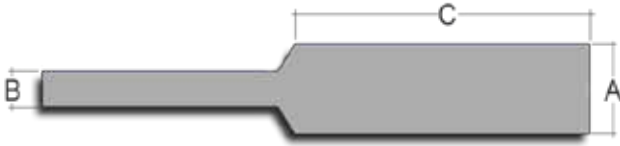

## EPP

**Tappi con maniglia di estrazione E.P.D.M. 177 °C**  
Indicati per verniciatura a liquido, platinatura, anodizzazione e sabbiatura. Ideali per fori passanti.



**E.P.D.M. Pull Plug 177 °C**  
Recommended for painting, plating, anodizing and blasting. Ideal for through holes.

| CODICE CODE | A    | B    | C     | PCS BOX | €/BOX |
|-------------|------|------|-------|---------|-------|
| EPP06       | 1,57 | 1,02 | 12,70 | 500     | 16,86 |
| EPP07       | 1,70 | 1,19 | 15,88 | 500     | 17,94 |
| EPP08(1)    | 1,85 | 1,17 | 15,54 | 500     | 21,21 |
| EPP09       | 2,31 | 1,32 | 15,88 | 500     | 21,72 |
| EPP10(2)    | 2,36 | 1,27 | 15,88 | 500     | 23,87 |
| EPP95-1000  | 2,41 | 1,32 | 25,40 | 500     | 27,96 |
| EPP10A      | 2,67 | 2,08 | 25,40 | 500     | 26,67 |
| EPP11       | 2,77 | 1,57 | 25,40 | 500     | 27,96 |
| EPP11B      | 3,00 | 2,08 | 25,40 | 500     | 38,55 |
| EPP11A(3)   | 3,18 | 1,57 | 15,88 | 500     | 38,97 |
| EPP15       | 3,30 | 2,36 | 15,88 | 500     | 34,57 |
| EPP14       | 3,30 | 2,36 | 25,40 | 500     | 39,84 |
| EPP17       | 3,56 | 2,16 | 15,88 | 500     | 34,36 |
| EPP18       | 3,91 | 1,57 | 15,88 | 500     | 34,01 |
| EPP20(4A)   | 3,96 | 1,57 | 15,88 | 500     | 36,69 |
| EPP21       | 4,01 | 2,08 | 31,75 | 500     | 41,48 |
| EPP22       | 4,11 | 2,44 | 15,88 | 500     | 41,46 |
| EPP23(4)    | 4,95 | 2,79 | 25,40 | 500     | 49,42 |
| EPP26       | 5,00 | 2,79 | 25,40 | 500     | 56,07 |
| EPP30       | 5,54 | 3,30 | 25,40 | 500     | 71,23 |
| EPP33       | 5,72 | 3,18 | 25,40 | 500     | 74,15 |
| EPP37(5)    | 6,53 | 3,30 | 25,40 | 500     | 81,67 |
| EPP40       | 6,99 | 3,18 | 23,80 | 500     | 84,92 |
| EPP42(6)    | 7,92 | 3,73 | 25,40 | 500     | 92,00 |

| CODICE CODE | A     | B     | C     | PCS BOX | €/BOX  |
|-------------|-------|-------|-------|---------|--------|
| EPP42A      | 8,43  | 6,35  | 28,58 | 500     | 107,05 |
| EPP43       | 8,51  | 3,89  | 25,40 | 500     | 170,91 |
| EPP50       | 9,53  | 3,99  | 25,40 | 500     | 171,99 |
| EPP55(7)    | 9,86  | 3,99  | 25,40 | 250     | 68,05  |
| EPP400-1000 | 10,16 | 3,99  | 24,40 | 250     | 94,91  |
| EPP60       | 10,36 | 4,85  | 25,63 | 250     | 124,57 |
| EPP63       | 10,52 | 3,99  | 13,34 | 250     | 124,84 |
| EPP66(8)    | 11,28 | 6,48  | 25,40 | 250     | 124,99 |
| EPP67(8)    | 11,30 | 6,48  | 25,40 | 250     | 128,89 |
| EPP70       | 11,89 | 6,35  | 25,40 | 250     | 130,62 |
| EPP73(9)    | 12,60 | 6,35  | 25,40 | 250     | 131,57 |
| EPP77       | 12,95 | 6,50  | 25,40 | 250     | 135,36 |
| EPP80(10)   | 13,46 | 6,35  | 25,40 | 250     | 145,59 |
| EPP87       | 15,54 | 6,35  | 25,40 | 100     | 74,98  |
| EPP88       | 15,75 | 8,36  | 38,10 | 100     | 121,74 |
| EPP90(11)   | 16,26 | 9,53  | 25,40 | 100     | 84,27  |
| EPP95       | 17,78 | 9,53  | 31,75 | 100     | 124,25 |
| EPP100(12)  | 19,56 | 9,53  | 25,40 | 100     | 125,43 |
| EPP110(13)  | 22,76 | 9,53  | 25,40 | 50      | 60,05  |
| EPP120(14)  | 25,91 | 9,53  | 25,40 | 50      | 90,17  |
| EPP130      | 35,05 | 12,70 | 25,40 | 50      | 167,91 |



FORME E DIMENSIONI PERSONALIZZATE REALIZZABILI SU RICHIESTA

# WE SOLVE EVERY MASKING PROBLEM



## Tappi Conici 315 °C.

Indicato per rivestimenti in polvere, elettrostatici per immersione liquida e platinatura. Riutilizzabili.



## Conical Plugs 315 °C.

Recommended for powder coating, E-coating and plating. Reusable.

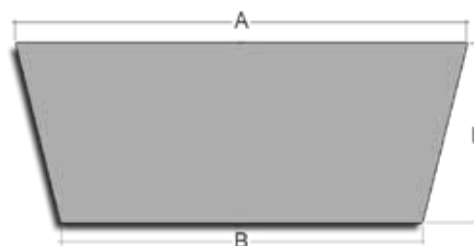

| CODICE CODE | A     | B     | L     | PCS BOX | €/BOX  | CODICE CODE | A      | B     | L     | PCS BOX | €/BOX  |
|-------------|-------|-------|-------|---------|--------|-------------|--------|-------|-------|---------|--------|
| EP63        | 1,60  | 0,41  | 15,88 | 1000    | 36,85  | EP1         | 19,00  | 14,27 | 25,40 | 100     | 56,55  |
| EP78        | 1,98  | 0,51  | 19,05 | 1000    | 41,25  | EP2         | 19,99  | 15,88 | 25,40 | 100     | 74,20  |
| EP81        | 2,54  | 0,81  | 15,88 | 1000    | 46,04  | EP2,5       | 20,62  | 15,88 | 25,40 | 100     | 83,07  |
| EP99        | 3,18  | 0,79  | 15,88 | 1000    | 51,54  | EP3         | 23,83  | 18,26 | 25,40 | 100     | 91,94  |
| EP100       | 3,18  | 1,60  | 15,88 | 1000    | 52,03  | EP3,5       | 25,00  | 17,00 | 25,40 | 100     | 97,48  |
| EP101SH     | 4,75  | 2,79  | 10,01 | 1000    | 51,10  | EP4         | 25,40  | 19,84 | 25,40 | 100     | 105,30 |
| EP101       | 4,75  | 1,60  | 15,88 | 1000    | 54,55  | EP4,5       | 26,01  | 19,99 | 25,40 | 100     | 112,41 |
| EP101XL     | 4,75  | 1,60  | 19,05 | 1000    | 66,66  | EP5         | 27,00  | 23,01 | 25,40 | 100     | 119,52 |
| EP101SXL    | 4,75  | 1,60  | 25,40 | 1000    | 77,19  | EP5,5       | 27,94  | 23,83 | 25,40 | 100     | 148,83 |
| EP102       | 6,35  | 3,18  | 19,05 | 1000    | 84,81  | EP6         | 31,75  | 26,19 | 25,40 | 100     | 151,83 |
| EP102XL     | 6,35  | 3,18  | 25,40 | 1000    | 89,74  | EP6,5       | 33,35  | 27,00 | 25,40 | 100     | 163,10 |
| EP103       | 8,71  | 4,78  | 15,88 | 1000    | 111,60 | EP7         | 36,53  | 30,18 | 25,40 | 10      | 23,09  |
| EP103XL     | 8,71  | 4,78  | 25,40 | 1000    | 142,07 | EP7,5       | 38,89  | 31,75 | 25,40 | 10      | 25,29  |
| EP105       | 9,53  | 6,35  | 12,70 | 100     | 22,31  | EP8         | 41,28  | 33,35 | 25,40 | 10      | 25,58  |
| EP104       | 9,53  | 6,35  | 19,05 | 100     | 19,67  | EP8,5       | 42,88  | 35,71 | 25,40 | 10      | 26,13  |
| EP375XL     | 9,53  | 3,18  | 31,75 | 100     | 60,83  | EP9         | 44,45  | 37,31 | 25,40 | 10      | 26,68  |
| EP394XL     | 10,01 | 5,00  | 48,01 | 100     | 69,96  | EP9,5       | 46,05  | 38,10 | 25,40 | 10      | 39,59  |
| EP104XL     | 11,10 | 6,35  | 25,40 | 100     | 25,10  | EP10        | 50,01  | 41,28 | 25,40 | 10      | 40,69  |
| EP106       | 11,13 | 8,74  | 17,48 | 100     | 30,83  | EP10,5      | 52,40  | 44,45 | 25,40 | 10      | 43,99  |
| EP000       | 11,91 | 8,74  | 20,65 | 100     | 27,13  | EP11        | 55,96  | 47,63 | 25,40 | 1       | 5,27   |
| EP000XL     | 12,70 | 7,90  | 25,40 | 100     | 34,05  | EP11,5      | 62,71  | 50,01 | 25,40 | 1       | 7,21   |
| EP500XL     | 12,70 | 3,20  | 50,80 | 100     | 72,16  | EP12        | 63,50  | 53,98 | 25,40 | 1       | 7,43   |
| EP107       | 14,30 | 7,95  | 25,40 | 100     | 36,29  | EP13        | 68,28  | 57,94 | 25,40 | 1       | 9,56   |
| EP107XL     | 15,01 | 3,00  | 35,00 | 100     | 64,13  | EP13,5      | 75,01  | 61,93 | 34,93 | 1       | 14,29  |
| EP00        | 15,09 | 10,31 | 25,40 | 100     | 36,78  | EP13,78     | 82,00  | 68,00 | 35,00 | 1       | 15,39  |
| EP108       | 15,88 | 11,13 | 22,23 | 100     | 55,88  | EP14        | 88,90  | 76,20 | 38,10 | 1       | 16,49  |
| EP0         | 16,66 | 12,70 | 25,40 | 100     | 52,50  | EP15        | 101,60 | 82,55 | 38,10 | 1       | 29,04  |
| EP109       | 17,45 | 11,13 | 25,40 | 100     | 55,13  | EP16        | 127,00 | 88,90 | 50,80 | 1       | 47,37  |

5 boxes **-20%**



FORME E DIMENSIONI PERSONALIZZATE REALIZZABILI SU RICHIESTA

[info@euromask-shop.com](mailto:info@euromask-shop.com)

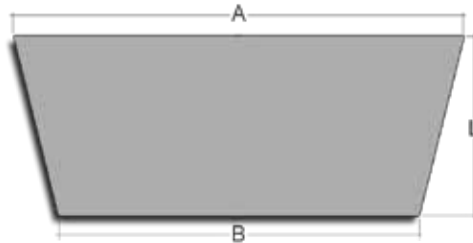

## Tappi Conici neri in E.P.D.M. 177 °C.

Indicati per verniciatura a liquido, platinatura, anodizzazione e sabbiatura.



## Black E.P.D.M. Conical Plugs 177 °C.

Recommended for painting, plating, anodizing and blasting.

| CODICE CODE | A     | B     | L     | PCS BOX | €/BOX  | CODICE CODE | A      | B     | L     | PCS BOX | €/BOX  |
|-------------|-------|-------|-------|---------|--------|-------------|--------|-------|-------|---------|--------|
| BP63        | 1,60  | 0,41  | 15,88 | 1000    | 27,74  | BP1         | 19,00  | 14,27 | 25,40 | 100     | 35,59  |
| BP78        | 1,98  | 0,51  | 19,05 | 1000    | 31,05  | BP2         | 19,99  | 15,88 | 25,40 | 100     | 41,17  |
| BP81        | 2,54  | 0,81  | 15,88 | 1000    | 34,65  | BP2,5       | 20,62  | 15,88 | 25,40 | 100     | 42,65  |
| BP99        | 3,18  | 0,79  | 15,88 | 1000    | 38,15  | BP3         | 23,83  | 18,26 | 25,40 | 100     | 56,50  |
| BP100       | 3,18  | 1,60  | 15,88 | 1000    | 41,24  | BP3,5       | 25,00  | 17,00 | 25,40 | 100     | 55,52  |
| BP101SH     | 4,75  | 2,79  | 10,01 | 1000    | 41,39  | BP4         | 25,40  | 19,84 | 25,40 | 100     | 65,17  |
| BP101       | 4,75  | 1,60  | 15,88 | 1000    | 42,83  | BP4,5       | 26,01  | 19,99 | 25,40 | 100     | 67,39  |
| BP101XL     | 4,75  | 1,60  | 19,05 | 1000    | 50,17  | BP5         | 27,00  | 23,01 | 25,40 | 100     | 79,28  |
| BP101SXL    | 4,75  | 1,60  | 25,40 | 1000    | 67,47  | BP5,5       | 27,94  | 23,83 | 25,40 | 100     | 84,87  |
| BP102       | 6,35  | 3,18  | 19,05 | 1000    | 48,27  | BP6         | 31,75  | 26,19 | 25,40 | 100     | 106,24 |
| BP102XL     | 6,35  | 3,18  | 25,40 | 1000    | 66,40  | BP6,5       | 33,35  | 27,00 | 25,40 | 100     | 115,30 |
| BP103       | 8,71  | 4,78  | 15,88 | 1000    | 60,55  | BP7         | 36,53  | 30,18 | 25,40 | 100     | 140,65 |
| BP103XL     | 8,71  | 4,78  | 25,40 | 1000    | 106,94 | BP7,5       | 38,89  | 31,75 | 25,40 | 50      | 78,86  |
| BP105       | 9,53  | 6,35  | 12,70 | 100     | 17,78  | BP8         | 41,28  | 33,35 | 25,40 | 50      | 88,01  |
| BP104       | 9,53  | 6,35  | 19,05 | 100     | 12,68  | BP8,5       | 42,88  | 35,71 | 25,40 | 50      | 97,47  |
| BP375XL     | 9,53  | 3,18  | 31,75 | 100     | 33,47  | BP9         | 44,45  | 37,31 | 25,40 | 50      | 105,46 |
| BP394XL     | 10,01 | 5,00  | 48,01 | 100     | 37,33  | BP9,5       | 46,05  | 38,10 | 25,40 | 50      | 111,73 |
| BP104XL     | 11,10 | 6,35  | 25,40 | 100     | 13,32  | BP10        | 50,01  | 41,28 | 25,40 | 50      | 131,46 |
| BP106       | 11,13 | 8,74  | 17,48 | 100     | 18,66  | BP10,5      | 52,40  | 44,45 | 25,40 | 50      | 147,81 |
| BP000       | 11,91 | 8,74  | 20,65 | 100     | 21,70  | BP11        | 55,96  | 47,63 | 25,40 | 1       | 3,38   |
| BP000XL     | 12,70 | 7,90  | 25,40 | 100     | 25,62  | BP11,5      | 62,71  | 50,01 | 25,40 | 1       | 4,01   |
| BP500XL     | 12,70 | 3,20  | 50,80 | 100     | 52,01  | BP12        | 63,50  | 53,98 | 25,40 | 1       | 4,35   |
| BP107       | 14,30 | 7,95  | 25,40 | 100     | 18,66  | BP13        | 68,28  | 57,94 | 25,40 | 1       | 5,01   |
| BP107XL     | 15,01 | 3,00  | 35,00 | 100     | 48,28  | BP13,5      | 75,01  | 61,93 | 34,93 | 1       | 8,12   |
| BP00        | 15,09 | 10,31 | 25,40 | 100     | 24,67  | BP13,78     | 68,00  | 82,00 | 35,00 | 1       | 11,10  |
| BP108       | 15,88 | 11,13 | 22,23 | 100     | 25,12  | BP14        | 88,90  | 76,20 | 38,10 | 1       | 12,86  |
| BP0         | 16,66 | 12,70 | 25,40 | 100     | 28,81  | BP15        | 101,60 | 82,55 | 38,10 | 1       | 16,02  |
| BP109       | 17,45 | 11,13 | 25,40 | 100     | 30,71  | BP16        | 127,00 | 88,90 | 50,80 | 1       | 29,57  |

5 boxes **-20%**



FORME E DIMENSIONI PERSONALIZZATE REALIZZABILI SU RICHIESTA



# WE SOLVE EVERY MASKING PROBLEM

 Rivestimenti in polvere Cappucci 315 °C.

 Powder Coating Caps 315 °C.



| CODICE CODE | A    | C    | L     | PCS BOX | €/BOX  | CODICE CODE | A    | C     | L     | PCS BOX | €/BOX  |
|-------------|------|------|-------|---------|--------|-------------|------|-------|-------|---------|--------|
| EC20        | 0,51 | 3,55 | 12,70 | 1000    | 28,00  | EC172-1500  | 4,37 | 7,41  | 38,10 | 1000    | 135,93 |
| EC35        | 0,89 | 3,43 | 12,70 | 1000    | 31,67  | EC180       | 4,57 | 7,61  | 25,40 | 1000    | 125,28 |
| EC40-500    | 1,02 | 3,32 | 12,70 | 1000    | 28,86  | EC187-500   | 4,75 | 7,79  | 12,70 | 1000    | 116,50 |
| EC40-750    | 1,02 | 3,30 | 19,05 | 1000    | 36,19  | EC187-750   | 4,75 | 7,79  | 19,05 | 1000    | 124,83 |
| EC62-750    | 1,57 | 3,80 | 19,05 | 1000    | 55,67  | EC187       | 4,75 | 7,79  | 25,40 | 1000    | 127,50 |
| EC70        | 1,78 | 4,08 | 25,40 | 1000    | 63,99  | EC187-1500  | 4,75 | 7,79  | 38,10 | 1000    | 142,89 |
| EC80-750    | 2,03 | 5,07 | 19,05 | 1000    | 67,11  | EC197-500   | 5,00 | 8,04  | 12,70 | 500     | 73,48  |
| EC93-500    | 2,36 | 4,95 | 12,70 | 1000    | 64,85  | EC218       | 5,54 | 8,58  | 25,40 | 500     | 70,55  |
| EC93-750    | 2,36 | 4,95 | 19,05 | 1000    | 68,31  | EC223-500   | 5,66 | 8,70  | 12,70 | 500     | 57,64  |
| EC100-500   | 2,54 | 5,13 | 12,70 | 1000    | 65,95  | EC223-750   | 5,66 | 8,70  | 19,05 | 500     | 62,57  |
| EC100-750   | 2,54 | 5,13 | 19,05 | 1000    | 70,99  | EC223-1000  | 5,66 | 8,70  | 25,40 | 500     | 65,95  |
| EC100       | 2,54 | 5,13 | 25,40 | 1000    | 80,40  | EC223       | 5,66 | 8,70  | 38,10 | 500     | 73,63  |
| EC100-1500  | 2,54 | 5,58 | 38,10 | 1000    | 137,90 | EC234-500   | 5,94 | 8,98  | 12,70 | 500     | 64,64  |
| EC109-500   | 2,77 | 5,81 | 12,70 | 1000    | 66,00  | EC234-750   | 5,94 | 8,98  | 20,00 | 500     | 69,92  |
| EC109       | 2,77 | 5,36 | 19,05 | 1000    | 71,60  | EC234       | 5,94 | 8,98  | 25,40 | 500     | 75,64  |
| EC125-500   | 3,18 | 5,77 | 12,70 | 1000    | 67,11  | EC234-1500  | 5,94 | 8,98  | 38,10 | 500     | 88,84  |
| EC125-750   | 3,18 | 6,22 | 19,05 | 1000    | 76,98  | EC250-500   | 6,35 | 9,39  | 12,70 | 500     | 53,33  |
| EC125       | 3,18 | 5,77 | 25,40 | 1000    | 85,90  | EC250       | 6,35 | 9,39  | 25,40 | 500     | 76,15  |
| EC125-1500  | 3,18 | 6,22 | 38,10 | 1000    | 143,88 | EC260       | 6,60 | 9,64  | 25,40 | 500     | 80,55  |
| EC137-1000  | 3,48 | 6,52 | 25,40 | 1000    | 91,92  | EC281       | 7,14 | 10,18 | 25,40 | 500     | 81,70  |
| EC140-500   | 3,56 | 6,60 | 12,70 | 1000    | 80,44  | EC281-2000  | 7,14 | 10,18 | 50,80 | 500     | 146,97 |
| EC140       | 3,56 | 6,60 | 25,40 | 1000    | 93,81  | EC295-500   | 7,49 | 10,53 | 12,70 | 500     | 83,47  |
| EC148-500   | 3,76 | 6,80 | 12,70 | 1000    | 83,36  | EC295-750   | 7,49 | 10,53 | 19,05 | 500     | 87,89  |
| EC148-750   | 3,76 | 6,80 | 19,05 | 1000    | 93,71  | EC295-1000  | 7,49 | 10,53 | 25,40 | 500     | 92,31  |
| EC148       | 3,76 | 6,80 | 25,40 | 1000    | 107,37 | EC295       | 7,49 | 10,53 | 38,10 | 500     | 85,67  |
| EC148-1500  | 3,76 | 6,80 | 38,10 | 1000    | 151,51 | EC295-2350  | 7,49 | 10,53 | 59,00 | 500     | 137,07 |
| EC156-500   | 3,96 | 7,00 | 12,70 | 1000    | 86,57  | EC312       | 7,92 | 10,96 | 25,40 | 500     | 94,44  |
| EC156       | 3,96 | 7,00 | 25,40 | 1000    | 110,41 | EC312-1500  | 7,92 | 10,96 | 38,10 | 500     | 132,77 |
| EC165-1000  | 4,19 | 7,23 | 25,40 | 1000    | 115,93 | EC340       | 8,64 | 11,68 | 25,40 | 500     | 105,55 |
| EC172-500   | 4,37 | 7,41 | 12,70 | 1000    | 92,05  | EC355       | 9,02 | 12,06 | 38,10 | 500     | 126,54 |
| EC172       | 4,37 | 7,41 | 25,40 | 1000    | 121,00 |             |      |       |       |         |        |

5 boxes -20%



FORME E DIMENSIONI PERSONALIZZATE REALIZZABILI SU RICHIESTA



| CODICE CODE | A     | C     | L     | PCS BOX | €/BOX  | CODICE CODE | A     | C     | L     | PCS BOX | €/BOX  |
|-------------|-------|-------|-------|---------|--------|-------------|-------|-------|-------|---------|--------|
| EC375-750   | 9,53  | 12,57 | 19,05 | 500     | 88,22  | EC687       | 17,45 | 20,49 | 38,10 | 250     | 106,37 |
| EC375       | 9,53  | 12,57 | 25,40 | 500     | 99,42  | EC687-2500  | 17,45 | 20,49 | 63,50 | 250     | 172,87 |
| EC375-1500  | 9,53  | 12,57 | 38,10 | 500     | 136,30 | EC730       | 18,54 | 21,58 | 38,10 | 250     | 110,04 |
| EC375-1969  | 9,53  | 12,57 | 50,01 | 500     | 172,39 | EC750       | 19,05 | 22,09 | 38,10 | 250     | 112,77 |
| EC406       | 10,31 | 13,35 | 25,40 | 500     | 110,57 | EC750-2000  | 19,05 | 22,09 | 50,80 | 250     | 206,12 |
| EC406-1500  | 10,31 | 13,35 | 38,10 | 500     | 153,65 | EC750-3500  | 19,05 | 22,09 | 88,90 | 250     | 244,08 |
| EC437       | 11,10 | 14,14 | 25,40 | 500     | 130,78 | EC780       | 19,81 | 22,85 | 38,10 | 250     | 115,43 |
| EC437-2000  | 11,10 | 14,14 | 50,80 | 500     | 231,69 | EC812       | 20,62 | 23,66 | 38,10 | 250     | 120,78 |
| EC456-500   | 11,58 | 14,62 | 12,70 | 500     | 80,52  | EC845-2844  | 21,46 | 24,50 | 72,24 | 250     | 263,52 |
| EC456-750   | 11,58 | 14,62 | 19,05 | 500     | 105,13 | EC875-1000  | 22,23 | 25,27 | 25,40 | 250     | 111,24 |
| EC456-1000  | 11,58 | 14,62 | 25,40 | 500     | 130,15 | EC875       | 22,23 | 25,27 | 38,10 | 250     | 131,52 |
| EC456       | 11,58 | 14,62 | 38,10 | 500     | 138,50 | EC937       | 23,80 | 26,84 | 38,10 | 250     | 165,83 |
| EC456-1969  | 11,58 | 14,62 | 50,01 | 500     | 226,46 | EC970       | 24,64 | 27,68 | 38,10 | 250     | 169,13 |
| EC468       | 11,89 | 14,93 | 25,40 | 500     | 133,62 | EC1000      | 25,40 | 28,44 | 38,10 | 250     | 171,80 |
| EC468-1500  | 11,89 | 14,93 | 38,10 | 500     | 180,38 | EC1000-2000 | 25,40 | 28,44 | 50,80 | 250     | 244,65 |
| EC480-1000  | 12,19 | 15,23 | 25,40 | 500     | 124,66 | EC1062      | 26,97 | 30,01 | 38,10 | 100     | 80,55  |
| EC480       | 12,19 | 15,23 | 38,10 | 500     | 147,65 | EC1062-2000 | 26,97 | 30,01 | 50,80 | 100     | 101,60 |
| EC500-750   | 12,70 | 15,74 | 19,05 | 500     | 105,69 | EC1125      | 28,58 | 31,62 | 38,10 | 100     | 83,23  |
| EC500       | 12,70 | 15,74 | 38,10 | 500     | 151,62 | EC1187      | 30,15 | 33,19 | 38,10 | 100     | 88,57  |
| EC535-750   | 13,59 | 16,63 | 19,05 | 250     | 71,03  | EC1250      | 31,75 | 34,79 | 38,10 | 100     | 99,31  |
| EC535       | 13,59 | 16,63 | 38,10 | 250     | 87,86  | EC1350      | 34,29 | 37,33 | 38,10 | 100     | 104,70 |
| EC535-3000  | 13,59 | 16,63 | 76,20 | 250     | 202,04 | EC1380      | 35,05 | 38,09 | 38,10 | 100     | 107,94 |
| EC562-659   | 14,27 | 17,31 | 16,74 | 250     | 59,61  | EC1500      | 38,10 | 41,14 | 25,40 | 100     | 110,00 |
| EC562       | 14,27 | 17,31 | 38,10 | 250     | 90,15  | EC1500-1500 | 38,10 | 41,14 | 38,10 | 100     | 119,52 |
| EC600       | 15,24 | 18,28 | 38,10 | 250     | 91,30  | EC1500-1750 | 38,10 | 41,14 | 44,45 | 50      | 64,28  |
| EC625-750   | 15,88 | 18,92 | 19,05 | 250     | 94,07  | EC1625      | 41,28 | 44,32 | 50,80 | 50      | 138,13 |
| EC625-1125  | 15,88 | 18,92 | 28,58 | 250     | 90,34  | EC1750      | 44,45 | 47,49 | 50,80 | 50      | 171,80 |
| EC625-1250  | 15,88 | 18,92 | 31,75 | 250     | 97,85  | EC1875      | 47,63 | 50,67 | 50,80 | 50      | 182,42 |
| EC625       | 15,88 | 18,92 | 38,10 | 250     | 102,04 | EC2000      | 50,80 | 53,84 | 50,80 | 50      | 214,74 |
| EC625-2500  | 15,88 | 18,92 | 63,50 | 250     | 198,41 | EC2105      | 53,47 | 56,51 | 50,80 | 50      | 238,36 |

5 boxes **-20%**



FORME E DIMENSIONI PERSONALIZZATE REALIZZABILI SU RICHIESTA

# WE SOLVE EVERY MASKING PROBLEM



## Cappucci in E.P.D.M. 177 °C.

Indicati per verniciatura a liquido, platinatura, anodizzazione. Riutilizzabili.



## E.P.D.M. Caps 177 °C.

Recommended for painting, plating and anodizing. Reusable.



| CODICE CODE | A    | C    | L     | PCS BOX | €/BOX | CODICE CODE | A    | C     | L     | PCS BOX | €/BOX  |
|-------------|------|------|-------|---------|-------|-------------|------|-------|-------|---------|--------|
| EE20-500    | 0,51 | 3,55 | 12,70 | 1000    | 21,65 | EE172-1000  | 4,37 | 7,41  | 25,40 | 1000    | 47,98  |
| EE35-500    | 0,89 | 3,43 | 12,70 | 1000    | 22,25 | EE172-1500  | 4,37 | 7,41  | 38,10 | 1000    | 75,51  |
| EE40-500    | 1,02 | 3,32 | 12,70 | 1000    | 20,88 | EE180-1000  | 4,57 | 7,61  | 25,40 | 1000    | 55,28  |
| EE40-750    | 1,02 | 3,30 | 19,05 | 1000    | 25,85 | EE187-500   | 4,75 | 7,79  | 12,70 | 1000    | 39,97  |
| EE62-750    | 1,57 | 4,61 | 19,05 | 1000    | 32,00 | EE187-750   | 4,75 | 7,79  | 19,05 | 1000    | 52,97  |
| EE70-1000   | 1,78 | 4,08 | 25,40 | 1000    | 32,28 | EE187-1000  | 4,75 | 7,79  | 25,40 | 1000    | 51,15  |
| EE80-750    | 2,03 | 5,07 | 19,05 | 1000    | 37,82 | EE187-1500  | 4,75 | 7,79  | 38,10 | 1000    | 80,18  |
| EE93-500    | 2,36 | 4,95 | 12,70 | 1000    | 32,71 | EE197-500   | 5,00 | 8,04  | 12,70 | 500     | 17,71  |
| EE93-750    | 2,36 | 4,95 | 19,05 | 1000    | 33,40 | EE218-1000  | 5,54 | 8,58  | 25,40 | 500     | 32,12  |
| EE93-1000   | 2,36 | 5,40 | 25,40 | 1000    | 39,38 | EE223-500   | 5,66 | 8,70  | 12,70 | 500     | 20,18  |
| EE100-500   | 2,54 | 5,13 | 12,70 | 1000    | 33,49 | EE223-750   | 5,66 | 8,70  | 19,05 | 500     | 30,57  |
| EE100-1000  | 2,54 | 5,13 | 25,40 | 1000    | 33,74 | EE223-1000  | 5,66 | 8,70  | 25,40 | 500     | 29,50  |
| EE100-1500  | 2,54 | 5,58 | 38,10 | 1000    | 57,48 | EE223-1500  | 5,66 | 8,70  | 38,10 | 500     | 45,97  |
| EE109-500   | 2,77 | 5,81 | 12,70 | 1000    | 33,40 | EE234-500   | 5,94 | 8,98  | 12,70 | 500     | 20,39  |
| EE109-750   | 2,77 | 5,36 | 19,05 | 1000    | 36,05 | EE234-787   | 5,94 | 8,98  | 19,99 | 500     | 28,37  |
| EE125-500   | 3,18 | 5,77 | 12,70 | 1000    | 33,40 | EE234-1000  | 5,94 | 8,98  | 25,40 | 500     | 30,69  |
| EE125-750   | 3,18 | 6,22 | 19,05 | 1000    | 35,66 | EE234-1500  | 5,94 | 8,98  | 38,10 | 500     | 55,75  |
| EE125-1000  | 3,18 | 5,77 | 25,40 | 1000    | 37,57 | EE250-500   | 6,35 | 9,39  | 12,70 | 500     | 25,28  |
| EE125-1500  | 3,18 | 6,22 | 38,10 | 1000    | 64,04 | EE250-1000  | 6,35 | 9,39  | 25,40 | 500     | 32,37  |
| EE137-1000  | 3,48 | 6,52 | 25,40 | 1000    | 50,22 | EE260-1000  | 6,60 | 9,64  | 25,40 | 500     | 37,35  |
| EE140-500   | 3,56 | 6,60 | 12,70 | 1000    | 33,40 | EE281-1000  | 7,14 | 10,18 | 25,40 | 500     | 35,90  |
| EE140-1000  | 3,56 | 6,60 | 25,40 | 1000    | 41,50 | EE281-2000  | 7,14 | 10,18 | 50,80 | 500     | 83,55  |
| EE148-500   | 3,76 | 6,80 | 12,70 | 1000    | 33,75 | EE295-500   | 7,49 | 10,53 | 12,70 | 500     | 29,41  |
| EE148-750   | 3,76 | 6,80 | 19,05 | 1000    | 36,44 | EE295-750   | 7,49 | 10,53 | 19,05 | 500     | 38,95  |
| EE148-1000  | 3,76 | 6,80 | 25,40 | 1000    | 43,11 | EE295-1000  | 7,49 | 10,53 | 25,40 | 500     | 37,29  |
| EE148-1500  | 3,76 | 6,80 | 38,10 | 1000    | 60,74 | EE295-1500  | 7,49 | 10,53 | 38,10 | 500     | 67,83  |
| EE156-500   | 3,96 | 7,00 | 12,70 | 1000    | 37,57 | EE295-2350  | 7,49 | 10,53 | 60,00 | 500     | 100,89 |
| EE156-1000  | 3,96 | 7,00 | 25,40 | 1000    | 44,74 | EE312-1000  | 7,92 | 10,96 | 25,40 | 500     | 39,27  |
| EE165-1000  | 4,19 | 7,23 | 25,40 | 1000    | 52,22 | EE312-1500  | 7,92 | 10,96 | 38,10 | 500     | 71,38  |
| EE172-500   | 4,37 | 7,41 | 12,70 | 1000    | 37,57 | EE340-1000  | 8,64 | 11,68 | 25,40 | 500     | 42,50  |

10 boxes -20%

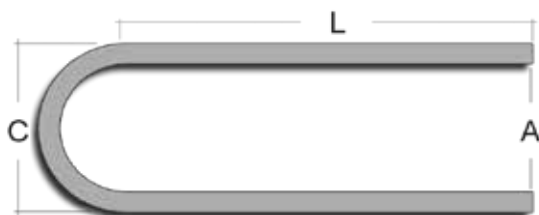

FORME E DIMENSIONI PERSONALIZZATE REALIZZABILI SU RICHIESTA





| CODICE CODE | A     | C     | L     | PCS BOX | €/BOX  | CODICE CODE | A     | C     | L     | PCS BOX | €/BOX  |
|-------------|-------|-------|-------|---------|--------|-------------|-------|-------|-------|---------|--------|
| EE355-1500  | 9,02  | 12,06 | 38,10 | 500     | 80,26  | EE687-1500  | 17,45 | 20,49 | 38,10 | 250     | 59,73  |
| EE375-750   | 9,53  | 12,57 | 19,05 | 500     | 48,90  | EE687-2500  | 17,45 | 20,49 | 63,50 | 250     | 101,36 |
| EE375-1000  | 9,53  | 12,57 | 25,40 | 500     | 46,81  | EE730-1500  | 18,54 | 21,58 | 38,10 | 250     | 71,19  |
| EE375-1500  | 9,53  | 12,57 | 38,10 | 500     | 84,46  | EE750-1500  | 19,05 | 22,09 | 38,10 | 250     | 65,76  |
| EE375-1969  | 9,53  | 12,57 | 50,01 | 500     | 106,55 | EE750-2000  | 19,05 | 22,09 | 50,80 | 250     | 92,14  |
| EE406-1000  | 10,31 | 13,35 | 25,40 | 500     | 50,50  | EE750-3500  | 19,05 | 22,09 | 88,90 | 250     | 148,86 |
| EE406-1500  | 10,31 | 13,35 | 38,10 | 500     | 90,88  | EE780-1500  | 19,81 | 22,85 | 38,10 | 250     | 76,58  |
| EE437-1000  | 11,10 | 14,14 | 25,40 | 500     | 54,43  | EE812-1500  | 20,62 | 23,66 | 38,10 | 250     | 71,81  |
| EE437-2000  | 11,10 | 14,14 | 50,80 | 500     | 106,94 | EE845-2844  | 21,46 | 24,50 | 72,24 | 250     | 140,39 |
| EE456-500   | 11,58 | 14,62 | 12,70 | 500     | 39,18  | EE875-1000  | 22,23 | 25,27 | 25,40 | 250     | 65,35  |
| EE456-750   | 11,58 | 14,62 | 19,05 | 500     | 51,26  | EE875-1500  | 22,23 | 25,27 | 38,10 | 250     | 78,20  |
| EE456-1000  | 11,58 | 14,62 | 25,40 | 500     | 56,64  | EE937-1500  | 23,80 | 26,84 | 38,10 | 250     | 84,53  |
| EE456-1500  | 11,58 | 14,62 | 38,10 | 500     | 87,25  | EE970-1500  | 24,64 | 27,68 | 38,10 | 250     | 98,14  |
| EE456-1969  | 11,58 | 14,62 | 50,01 | 500     | 109,76 | EE1000-1500 | 25,40 | 28,44 | 38,10 | 250     | 101,72 |
| EE468-1000  | 11,89 | 14,93 | 25,40 | 500     | 64,86  | EE1000-2000 | 25,40 | 28,44 | 50,80 | 250     | 126,41 |
| EE468-1500  | 11,89 | 14,93 | 38,10 | 500     | 89,50  | EE1062-1500 | 26,97 | 30,01 | 38,10 | 100     | 39,18  |
| EE480-1000  | 12,19 | 15,23 | 25,40 | 500     | 66,61  | EE1062-2000 | 26,97 | 30,01 | 50,80 | 100     | 54,11  |
| EE480-1500  | 12,19 | 15,23 | 38,10 | 500     | 91,77  | EE1125-1500 | 28,58 | 31,62 | 38,10 | 100     | 42,00  |
| EE500-750   | 12,70 | 15,74 | 19,05 | 500     | 56,37  | EE1187-1500 | 30,15 | 33,19 | 38,10 | 100     | 57,33  |
| EE500-1500  | 12,70 | 15,74 | 38,10 | 500     | 85,88  | EE1250-1500 | 31,75 | 34,79 | 38,10 | 100     | 59,28  |
| EE535-750   | 13,59 | 16,63 | 19,05 | 250     | 30,39  | EE1350-1500 | 34,29 | 37,33 | 38,10 | 100     | 68,25  |
| EE535-1500  | 13,59 | 16,63 | 38,10 | 250     | 45,98  | EE1380-1500 | 35,05 | 38,09 | 38,10 | 100     | 60,87  |
| EE535-3000  | 13,59 | 16,63 | 76,20 | 250     | 92,79  | EE1500-1000 | 38,10 | 41,14 | 25,40 | 100     | 61,02  |
| EE562-659   | 14,27 | 17,31 | 16,74 | 250     | 29,47  | EE1500-1500 | 38,10 | 41,14 | 38,10 | 100     | 64,29  |
| EE562-1500  | 14,27 | 17,31 | 38,10 | 250     | 48,38  | EE1500-1750 | 38,10 | 41,14 | 44,45 | 100     | 86,48  |
| EE600-1500  | 15,24 | 18,28 | 38,10 | 250     | 51,78  | EE1625-2000 | 41,28 | 44,32 | 50,80 | 50      | 40,31  |
| EE625-1125  | 15,88 | 18,92 | 28,58 | 250     | 48,16  | EE1750-2000 | 44,45 | 47,49 | 50,80 | 50      | 44,24  |
| EE625-1250  | 15,88 | 18,92 | 31,75 | 250     | 52,18  | EE1875-2000 | 47,63 | 50,67 | 50,80 | 50      | 62,77  |
| EE625-1500  | 15,88 | 18,92 | 38,10 | 250     | 54,04  | EE2000-2000 | 50,80 | 53,84 | 50,80 | 50      | 52,88  |
| EE625-2500  | 15,88 | 18,92 | 63,50 | 250     | 92,12  | EE2105-2000 | 53,47 | 56,51 | 50,80 | 50      | 72,92  |

10 boxes **-20%**



FORME E DIMENSIONI PERSONALIZZATE REALIZZABILI SU RICHIESTA

# WE SOLVE EVERY MASKING PROBLEM

**IT** Cappucci copri-faston 315 °C.

**UK** Square silicone caps 315 °C.



**EQ**

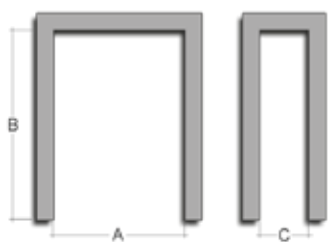

| CODICE CODE | A     | B     | C    | PCS BOX | €/BOX  |
|-------------|-------|-------|------|---------|--------|
| EQ157       | 3,99  | 19,99 | 0,61 | 1000    | 126,26 |
| EQ232       | 5,89  | 11,00 | 0,79 | 1000    | 128,80 |
| EQ250       | 6,35  | 10,92 | 0,79 | 1000    | 129,97 |
| EQ460       | 11,68 | 7,11  | 0,89 | 500     | 134,09 |
| EQ470       | 11,94 | 9,50  | 1,02 | 500     | 137,17 |
| EQ490       | 12,45 | 17,45 | 1,19 | 500     | 142,95 |



FORME E DIMENSIONI PERSONALIZZATE REALIZZABILI SU RICHIESTA

**CBI**

**IT** Cappucci con anelli interni 315 °C.

Gli anelli interni facilitano l'inserimento e l'estrazione su perni/filletteri lunghi e di grandi dimensioni ed aumentano la tenuta del cappuccio.

**UK** Caps with rings 315 °C.

Internal rings allow an easy handling on long pivots/threads with big diameters and increase cap tightness.



| CODICE CODE | Ød    | ØD    | L     | PCS BOX | €/BOX  |
|-------------|-------|-------|-------|---------|--------|
| CBI3-6      | 3,00  | 6,00  | 39,00 | 100     | 57,89  |
| CBI6-9      | 6,00  | 9,00  | 39,00 | 100     | 81,60  |
| CBI9-12     | 9,00  | 12,00 | 39,00 | 100     | 105,30 |
| CBI12-15    | 12,00 | 15,00 | 39,00 | 100     | 131,64 |
| CBI15-18    | 15,00 | 18,00 | 39,00 | 50      | 78,99  |
| CBI18-21    | 18,00 | 21,00 | 39,00 | 50      | 93,48  |
| CBI21-24    | 21,00 | 24,00 | 39,00 | 50      | 107,95 |
| CBI24-27    | 24,00 | 27,00 | 39,00 | 50      | 123,76 |
| CBI27-30    | 27,00 | 30,00 | 52,00 | 25      | 86,90  |
| CBI30-33    | 30,00 | 33,00 | 52,00 | 25      | 96,78  |
| CBI33-36    | 33,00 | 36,00 | 52,00 | 25      | 107,32 |
| CBI36-39    | 36,00 | 39,00 | 52,00 | 25      | 117,85 |
| CBI39-42    | 39,00 | 42,00 | 52,00 | 25      | 129,04 |
| CBI42-45    | 42,00 | 45,00 | 52,00 | 10      | 56,09  |
| CBI45-48    | 45,00 | 48,00 | 52,00 | 10      | 60,83  |
| CBI48-51    | 48,00 | 51,00 | 52,00 | 10      | 65,57  |
| CBI51-54    | 51,00 | 54,00 | 52,00 | 10      | 70,58  |

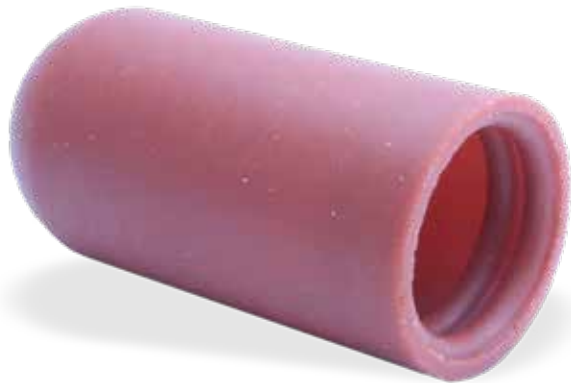

FORME E DIMENSIONI PERSONALIZZATE REALIZZABILI SU RICHIESTA

5 boxes -20%

**IT** Cappucci con flangia 315 °C.

Per la protezione di fori filettati e del primo filetto.

**UK** Caps with flange 315 °C.

To mask holes and first thread.

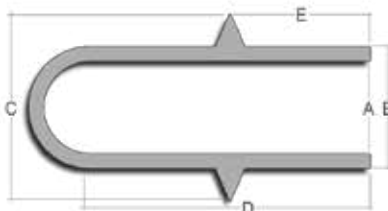

**CR**

| CODICE CODE | A     | B     | C     | D     | E     | PCS BOX | €/BOX  |
|-------------|-------|-------|-------|-------|-------|---------|--------|
| CR8         | 4,39  | 7,39  | 11,99 | 30,99 | 11,99 | 250     | 71,41  |
| CR10        | 5,69  | 8,71  | 13,00 | 32,00 | 14,71 | 250     | 96,28  |
| CR12        | 7,65  | 10,69 | 14,00 | 33,02 | 15,80 | 250     | 119,01 |
| CR12L       | 8,00  | 10,69 | 14,00 | 45,66 | 15,80 | 250     | 138,83 |
| CR14        | 10,69 | 13,69 | 15,01 | 34,04 | 18,01 | 250     | 156,13 |
| CR14L       | 9,55  | 12,70 | 17,02 | 57,15 | 17,53 | 250     | 226,07 |



FORME E DIMENSIONI PERSONALIZZATE REALIZZABILI SU RICHIESTA

# EUROMASK®



Cappucci a testa piatta 315 °C.



Flat caps 315 °C.

| CODICE CODE | A     | C     | L     | PCS BOX | €/BOX  | CODICE CODE | A     | C     | L      | PCS BOX | €/BOX  |
|-------------|-------|-------|-------|---------|--------|-------------|-------|-------|--------|---------|--------|
| FC70-1000   | 1,78  | 4,82  | 25,40 | 1000    | 63,15  | FC480-1500  | 12,19 | 15,23 | 38,10  | 500     | 174,69 |
| FC100-1000  | 2,54  | 5,58  | 25,40 | 1000    | 75,45  | FC535-1500  | 13,59 | 16,63 | 38,10  | 250     | 96,80  |
| FC100-1120  | 2,54  | 5,58  | 28,45 | 1000    | 82,41  | FC562-1500  | 14,27 | 17,31 | 38,10  | 250     | 101,31 |
| FC120-400   | 3,05  | 6,09  | 10,16 | 1000    | 43,03  | FC590-708   | 14,99 | 18,03 | 17,98  | 250     | 57,84  |
| FC120-1000  | 3,05  | 6,09  | 25,40 | 1000    | 83,70  | FC600-1500  | 15,24 | 18,28 | 38,10  | 250     | 108,02 |
| FC145-1120  | 3,68  | 6,72  | 28,45 | 1000    | 103,84 | FC640-900   | 16,26 | 19,30 | 22,86  | 250     | 75,50  |
| FC148-1000  | 3,76  | 6,80  | 25,40 | 1000    | 95,77  | FC640-2000  | 16,26 | 19,30 | 50,80  | 250     | 148,02 |
| FC172-800   | 4,37  | 7,41  | 20,32 | 1000    | 88,02  | FC665-732   | 16,89 | 19,93 | 18,59  | 250     | 67,05  |
| FC175-1000  | 4,45  | 7,49  | 25,40 | 1000    | 106,92 | FC687-330   | 17,45 | 20,49 | 8,38   | 250     | 41,22  |
| FC185-1120  | 4,70  | 7,74  | 28,45 | 1000    | 122,84 | FC722-4555  | 18,34 | 21,38 | 115,70 | 250     | 354,50 |
| FC220-1120  | 5,59  | 8,63  | 28,45 | 500     | 69,67  | FC728-452   | 18,49 | 21,53 | 11,48  | 250     | 53,10  |
| FC220-1650  | 5,59  | 8,63  | 41,91 | 500     | 97,53  | FC730-1500  | 18,54 | 21,58 | 38,10  | 250     | 131,11 |
| FC223-1500  | 5,66  | 8,70  | 38,10 | 500     | 90,67  | FC730-4000  | 18,54 | 21,58 | 101,60 | 250     | 316,91 |
| FC234-1500  | 5,94  | 8,98  | 38,10 | 500     | 94,09  | FC736-728   | 18,69 | 21,73 | 18,49  | 250     | 74,45  |
| FC295-250   | 7,49  | 10,53 | 6,35  | 500     | 30,22  | FC811-728   | 20,60 | 23,64 | 18,49  | 250     | 82,64  |
| FC295-1500  | 7,49  | 10,53 | 38,10 | 500     | 113,66 | FC855-1500  | 21,72 | 24,76 | 38,10  | 250     | 154,14 |
| FC300-1120  | 7,62  | 10,66 | 28,45 | 500     | 89,36  | FC921-728   | 23,39 | 26,43 | 18,49  | 250     | 95,23  |
| FC300-1650  | 7,62  | 10,66 | 41,91 | 500     | 125,29 | FC970-4000  | 24,64 | 27,68 | 101,60 | 250     | 418,24 |
| FC355-1500  | 9,02  | 12,06 | 38,10 | 500     | 132,84 | FC980-1500  | 24,89 | 27,93 | 38,10  | 250     | 177,88 |
| FC375-1120  | 9,53  | 12,57 | 28,45 | 500     | 108,37 | FC1000-650  | 25,40 | 28,44 | 16,51  | 250     | 96,91  |
| FC375-1500  | 9,53  | 12,57 | 38,10 | 500     | 139,52 | FC1291-905  | 32,79 | 35,83 | 22,99  | 100     | 65,84  |
| FC393-728   | 9,98  | 13,02 | 18,49 | 500     | 79,77  | FC1555-1102 | 39,50 | 42,54 | 27,99  | 50      | 47,23  |
| FC415-1500  | 10,54 | 13,58 | 38,10 | 500     | 152,96 | FC1649-1102 | 41,88 | 44,92 | 27,99  | 50      | 50,70  |
| FC437-1000  | 11,10 | 14,14 | 25,40 | 500     | 113,18 | FC1772-670  | 45,01 | 48,05 | 17,02  | 50      | 40,46  |
| FC440-728   | 11,18 | 14,22 | 18,49 | 500     | 88,58  | FC1850-1102 | 46,99 | 50,03 | 27,99  | 50      | 58,41  |
| FC456-1120  | 11,58 | 14,62 | 28,45 | 500     | 129,44 | FC1957-1515 | 49,71 | 52,75 | 38,48  | 50      | 78,34  |
| FC456-1500  | 11,58 | 14,62 | 38,10 | 500     | 166,57 | FC2885-1000 | 73,28 | 76,32 | 25,40  | 50      | 98,43  |

FORME E DIMENSIONI PERSONALIZZATE REALIZZABILI SU RICHIESTA

5 boxes **-20%**





# WE SOLVE EVERY MASKING PROBLEM



## Cappucci ad uso facilitato 315 °C.

L'anello interno migliora la tenuta del cappuccio, mentre la rondella ne permette una facile estrazione.



## Easy use caps 315 °C.

Internal ring improve cap tightness and the flange in the head allows an easy handling.



| CODICE CODE | A     | B     | C     | L     | PCS BOX | €/BOX  | CODICE CODE  | A     | B      | C     | L      | PCS BOX | €/BOX  |
|-------------|-------|-------|-------|-------|---------|--------|--------------|-------|--------|-------|--------|---------|--------|
| SZC125-2000 | 3,18  | 16,51 | 6,35  | 50,80 | 500     | 257,33 | SZC492-1180  | 12,50 | 25,83  | 15,67 | 29,97  | 250     | 178,62 |
| SZC135-1180 | 3,43  | 16,76 | 6,60  | 29,97 | 500     | 175,11 | SZC531-1180  | 13,49 | 26,82  | 16,66 | 29,97  | 100     | 75,75  |
| SZC138-1180 | 3,51  | 16,84 | 6,68  | 29,97 | 500     | 176,45 | SZC586-512   | 14,88 | 28,22  | 18,06 | 13,00  | 100     | 49,01  |
| SZC156-2000 | 3,96  | 17,30 | 7,14  | 50,80 | 500     | 280,06 | SZC587-374   | 14,91 | 28,24  | 18,08 | 9,50   | 100     | 42,26  |
| SZC157-1180 | 3,99  | 17,32 | 7,16  | 29,97 | 500     | 185,83 | SZC608-493   | 15,44 | 28,78  | 18,62 | 12,52  | 100     | 49,56  |
| SZC165-1016 | 4,19  | 17,53 | 7,37  | 25,81 | 500     | 170,07 | SZC608-1180  | 15,44 | 28,78  | 18,62 | 29,97  | 100     | 84,29  |
| SZC177-1180 | 4,50  | 17,83 | 7,67  | 29,97 | 500     | 195,43 | SZC622-1180  | 15,80 | 29,13  | 18,97 | 29,97  | 100     | 85,84  |
| SZC180-2000 | 4,57  | 17,91 | 7,75  | 50,80 | 500     | 297,40 | SZC622-1575  | 15,80 | 29,13  | 18,97 | 40,01  | 100     | 106,19 |
| SZC187-1377 | 4,75  | 18,08 | 7,92  | 34,98 | 500     | 224,79 | SZC687-1180  | 17,45 | 30,78  | 20,62 | 29,97  | 100     | 93,34  |
| SZC187-1747 | 4,75  | 18,08 | 7,92  | 44,37 | 500     | 271,16 | SZC689-3579  | 17,50 | 30,84  | 20,68 | 90,91  | 100     | 226,52 |
| SZC197-1180 | 5,00  | 15,80 | 9,40  | 37,00 | 250     | 93,03  | SZC725-3120  | 18,40 | 28,56  | 18,40 | 85,10  | 100     | 270,68 |
| SZC234-2000 | 5,94  | 19,28 | 9,12  | 50,80 | 250     | 168,71 | SZC850-410   | 21,59 | 34,93  | 24,77 | 10,41  | 100     | 62,43  |
| SZC236-1180 | 5,99  | 19,33 | 9,17  | 29,97 | 250     | 112,09 | SZC906-3500  | 23,01 | 36,35  | 26,19 | 88,90  | 100     | 278,70 |
| SZC255-910  | 6,48  | 19,81 | 9,65  | 23,11 | 250     | 97,15  | SZC963-3000  | 24,46 | 37,80  | 27,64 | 76,20  | 100     | 257,73 |
| SZC255-1180 | 6,48  | 19,81 | 9,65  | 29,97 | 250     | 116,86 | SZC980-1500  | 24,89 | 38,23  | 28,07 | 38,10  | 100     | 152,16 |
| SZC270-1200 | 6,86  | 20,19 | 10,03 | 30,48 | 250     | 122,21 | SZC980-1654  | 24,90 | 38,00  | 26,90 | 42,00  | 100     | 116,66 |
| SZC275-1180 | 6,99  | 20,32 | 10,16 | 29,97 | 250     | 121,94 | SZC1118-540  | 28,40 | 41,73  | 31,57 | 13,72  | 100     | 94,46  |
| SZC294-1330 | 7,47  | 20,80 | 10,64 | 33,78 | 250     | 138,49 | SZC1125-5000 | 28,58 | 41,91  | 31,75 | 127,00 | 50      | 230,13 |
| SZC315-974  | 8,00  | 21,34 | 11,18 | 24,74 | 250     | 115,23 | SZC1230-5000 | 31,24 | 44,58  | 34,42 | 127,00 | 50      | 249,29 |
| SZC315-1180 | 8,00  | 21,34 | 11,18 | 29,97 | 250     | 132,09 | SZC1240-1760 | 31,50 | 44,83  | 34,67 | 44,70  | 50      | 107,21 |
| SZC315-1425 | 8,00  | 21,34 | 11,18 | 36,20 | 250     | 152,15 | SZC1288-4128 | 32,72 | 46,05  | 35,89 | 104,85 | 50      | 219,96 |
| SZC320-670  | 8,13  | 21,46 | 11,30 | 17,02 | 250     | 91,10  | SZC1567-1517 | 39,80 | 53,14  | 42,98 | 38,53  | 50      | 107,47 |
| SZC330-1500 | 8,38  | 21,72 | 11,56 | 38,10 | 250     | 162,72 | SZC1850-1850 | 46,99 | 60,33  | 50,17 | 46,99  | 50      | 163,81 |
| SZC355-1500 | 9,02  | 22,35 | 12,19 | 38,10 | 250     | 170,58 | SZC1921-1575 | 48,79 | 62,13  | 51,97 | 40,01  | 50      | 157,61 |
| SZC360-1000 | 9,14  | 22,48 | 12,32 | 25,40 | 250     | 127,66 | SZC2244-1811 | 57,00 | 70,33  | 60,17 | 46,00  | 25      | 103,00 |
| SZC375-1000 | 9,53  | 22,86 | 12,70 | 25,40 | 250     | 131,16 | SZC2250-1920 | 57,15 | 70,49  | 60,33 | 48,77  | 25      | 110,30 |
| SZC375-1421 | 9,53  | 22,86 | 12,70 | 36,09 | 250     | 169,41 | SZC2500-2420 | 63,50 | 76,84  | 66,68 | 61,47  | 25      | 144,98 |
| SZC394-1180 | 10,01 | 23,34 | 13,18 | 29,97 | 250     | 152,49 | SZC2660-726  | 67,56 | 80,90  | 70,74 | 18,44  | 25      | 80,63  |
| SZC433-1180 | 11,00 | 24,33 | 14,17 | 29,97 | 250     | 162,72 | SZC2750-2670 | 69,90 | 84,40  | 74,30 | 69,60  | 25      | 170,92 |
| SZC438-950  | 11,13 | 24,46 | 14,30 | 24,13 | 250     | 141,03 | SZC3000-2920 | 76,20 | 89,00  | 79,38 | 74,17  | 25      | 199,85 |
| SZC451-1215 | 11,46 | 24,79 | 14,63 | 30,86 | 250     | 171,25 | SZC3154-730  | 80,11 | 92,68  | 83,29 | 18,54  | 25      | 102,36 |
| SZC485-750  | 12,32 | 25,65 | 15,49 | 19,05 | 250     | 130,50 | SZC3425-705  | 87,00 | 100,33 | 90,17 | 17,91  | 25      | 110,32 |
| SZC485-1013 | 12,32 | 25,65 | 15,49 | 25,73 | 250     | 158,82 | SZC3465-819  | 88,01 | 101,35 | 91,19 | 20,80  | 25      | 118,57 |
| SZC485-1600 | 12,32 | 26,29 | 16,12 | 40,64 | 250     | 192,90 | SZC3500-3420 | 88,90 | 102,24 | 92,08 | 86,87  | 25      | 271,54 |

5 boxes -20%

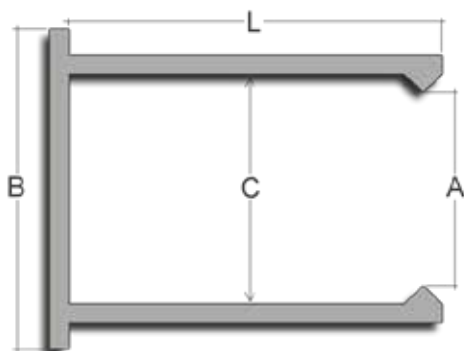

FORME E DIMENSIONI PERSONALIZZATE REALIZZABILI SU RICHIESTA



## Cappucci conici a rondella 315 °C.

Indicati per rivestimenti in polvere, elettrostatici per immersione liquida e platinatura.



## Silicone Conecaps 315 °C.

Recommended for powder coating, E-coating and plating.

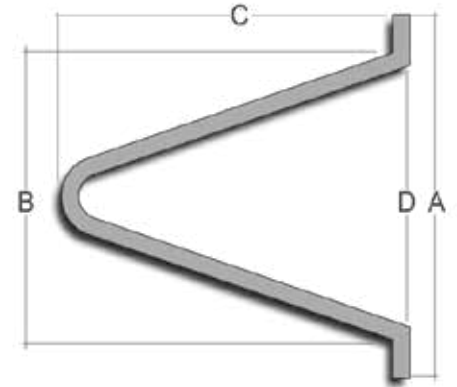

| CODICE CODE | A     | B     | C     | D     | PCS BOX | €/BOX  |
|-------------|-------|-------|-------|-------|---------|--------|
| CCC1        | 12,70 | 6,35  | 23,01 | 3,30  | 200     | 20,20  |
| CCC2        | 12,70 | 8,03  | 25,40 | 5,49  | 200     | 40,39  |
| CCC3        | 15,88 | 8,51  | 25,40 | 4,50  | 200     | 47,12  |
| CCC4        | 16,51 | 10,01 | 27,99 | 5,00  | 200     | 49,48  |
| CCC5        | 16,13 | 10,16 | 27,94 | 5,84  | 200     | 67,36  |
| CCC6        | 19,05 | 14,00 | 35,99 | 8,00  | 200     | 74,10  |
| CCC7        | 24,89 | 17,50 | 38,10 | 11,51 | 200     | 121,22 |
| CCC8        | 27,94 | 19,48 | 51,03 | 13,51 | 100     | 80,83  |
| CCC9        | 25,40 | 20,80 | 49,00 | 14,81 | 100     | 94,29  |
| CCC10       | 30,99 | 22,00 | 53,01 | 16,00 | 100     | 107,76 |

FORME E DIMENSIONI PERSONALIZZATE REALIZZABILI SU RICHIESTA



## Cappucci a rondella 315 °C.

Cappuccio a doppia funzione. Ideale per mascherare attorno a un foro per la messa a terra.



## Washer Caps 315 °C.

Dual purpose plug. Ideal for masking around hole for earthing purpose.

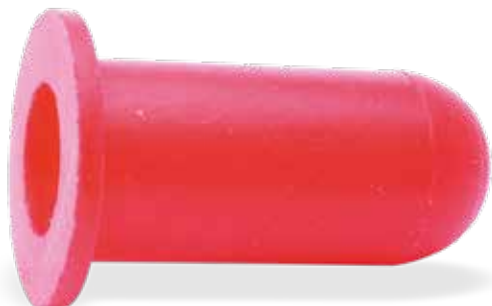
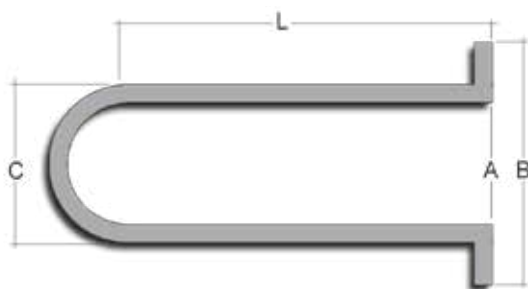

| CODICE CODE | A     | B     | C     | L     | PCS BOX | €/BOX  |
|-------------|-------|-------|-------|-------|---------|--------|
| CF100-500   | 2,54  | 12,70 | 5,72  | 25,40 | 500     | 60,62  |
| CF125-500   | 3,18  | 12,70 | 6,40  | 25,40 | 500     | 78,80  |
| CF140-500   | 3,56  | 12,70 | 8,20  | 25,40 | 500     | 105,57 |
| CF156-500   | 3,96  | 12,70 | 8,00  | 25,40 | 500     | 111,10 |
| CF172-500   | 4,37  | 12,70 | 9,70  | 25,40 | 500     | 121,21 |
| CF180-600   | 4,57  | 15,24 | 8,00  | 25,40 | 250     | 50,52  |
| CF220-500   | 5,59  | 14,99 | 9,09  | 25,40 | 250     | 55,57  |
| CF220-787   | 5,59  | 19,99 | 8,71  | 25,40 | 250     | 95,96  |
| CF295-500   | 7,49  | 12,70 | 10,49 | 25,40 | 250     | 82,48  |
| CF295-700   | 7,49  | 17,78 | 10,49 | 25,40 | 250     | 92,88  |
| CF295-1000  | 7,49  | 25,40 | 10,49 | 25,40 | 250     | 109,88 |
| CF300-675   | 7,62  | 17,15 | 10,59 | 25,40 | 250     | 101,76 |
| CF376-825   | 9,53  | 20,96 | 13,00 | 38,10 | 250     | 121,21 |
| CF460-700   | 11,68 | 17,78 | 14,50 | 25,40 | 100     | 79,55  |
| CF500-1000  | 12,70 | 25,40 | 15,39 | 25,40 | 100     | 84,85  |
| CF616-1180  | 15,62 | 29,97 | 20,70 | 38,10 | 100     | 106,06 |
| CF780-1475  | 19,81 | 37,47 | 24,69 | 25,40 | 100     | 126,26 |

FORME E DIMENSIONI PERSONALIZZATE REALIZZABILI SU RICHIESTA

# WE SOLVE EVERY MASKING PROBLEM



**Cappucci ventilati ad uso facilitato 315 °C.**  
Gli anelli interni migliorano la tenuta del cappuccio, il foro di 0.3mm evita accumuli di pressione interna.



**Vent easy use caps 315 °C.**  
Internal ring improve cap tightness and the vent hole reduce the internal pressure.

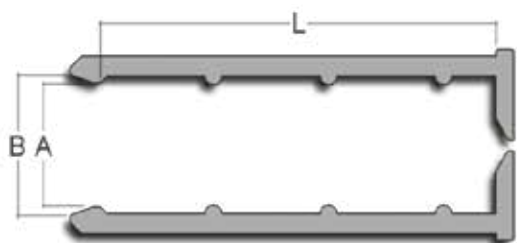

| CODICE CODE | A     | B     | L     | PCS BOX | €/BOX  |
|-------------|-------|-------|-------|---------|--------|
| VRZCM4      | 3,30  | 5,00  | 20,60 | 500     | 122,17 |
| VRZCM5      | 4,40  | 6,18  | 25,60 | 250     | 80,22  |
| VRZCM6      | 5,40  | 7,00  | 25,60 | 250     | 88,56  |
| VRZCM8      | 7,22  | 9,00  | 25,60 | 250     | 109,71 |
| VRZCM8L     | 7,22  | 9,00  | 50,60 | 250     | 168,89 |
| VRZCM10     | 9,22  | 11,00 | 25,60 | 250     | 122,20 |
| VRZCM12L    | 11,22 | 13,00 | 50,60 | 100     | 92,00  |
| VRZCM14L    | 13,22 | 15,00 | 50,60 | 100     | 104,30 |

5 boxes **-20%**

FORME E DIMENSIONI PERSONALIZZATE REALIZZABILI SU RICHIESTA



**Tappi ventilati senza flange 315 ° C.**  
Indicati per rivestimenti in polvere, elettrostatici per immersione liquida, platinatura e anodizzazione.  
Fori filettati. Forma conica e interno cavo per molteplici applicazioni.  
Proteggono i fori filettati senza mascherare la zona circostante. Il foro ventilato da 0.3mm evita l'accumulo di pressione interno



**Vent Flangeless Plugs 315 °C.**  
Recommended for powder coating, E-coating, plating and anodizing. Threaded holes. Tapered design and hollow core for multi-applications.  
Protect threaded holes without masking the surrounding area. 0.3mm vent hole on top avoid pressure buildup

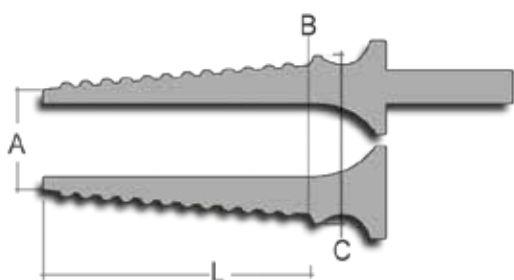

| CODICE CODE | A     | B     | C     | L     | PCS BOX | €/BOX  |
|-------------|-------|-------|-------|-------|---------|--------|
| VSP6x8      | 3,93  | 7,25  | 8,20  | 20,30 | 250     | 58,54  |
| VSP10x12    | 7,50  | 11,00 | 12,40 | 21,50 | 250     | 99,24  |
| VSP14x16    | 11,78 | 15,60 | 17,00 | 24,85 | 100     | 77,34  |
| VSP18x20    | 15,71 | 19,80 | 21,20 | 26,45 | 100     | 118,50 |
| VSP22x24    | 20,24 | 24,60 | 26,00 | 28,15 | 50      | 88,63  |

5 boxes **-20%**



FORME E DIMENSIONI PERSONALIZZATE REALIZZABILI SU RICHIESTA











## DHPP



Tappo speciale per protezione dadi a doppia maniglia 315 °C



Double handle special nut protection plug 315 °C

| CODICE CODE   | A     | B     | L     | PCS BOX | €/BOX  |
|---|-------|-------|-------|---------|--------|
|  DHPP05 | 4,10  | 5,40  | 3,00  | 500     | 61,43  |
|  DHPP06 | 5,10  | 6,70  | 3,80  | 500     | 77,38  |
|  DHPP08 | 6,70  | 8,70  | 5,35  | 500     | 88,99  |
|  DHPP10 | 8,50  | 11,20 | 6,60  | 250     | 79,67  |
|  DHPP12 | 10,10 | 13,00 | 6,60  | 250     | 96,35  |
|  DHPP14 | 12,10 | 15,20 | 8,00  | 100     | 71,51  |
|  DHPP16 | 13,90 | 16,60 | 9,30  | 100     | 91,35  |
|  DHPP18 | 15,90 | 20,00 | 10,70 | 100     | 116,44 |
|  DHPP20 | 17,80 | 21,01 | 12,30 | 50      | 73,09  |

5 boxes -20%

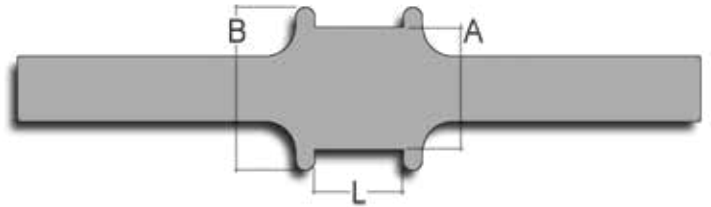





FORME E DIMENSIONI PERSONALIZZATE REALIZZABILI SU RICHIESTA

 **Tappi Doppi senza flangia 315 °C.**  
Protegge i fori filettati senza mascherare la zona circostante. Utile per due differenti diametri.

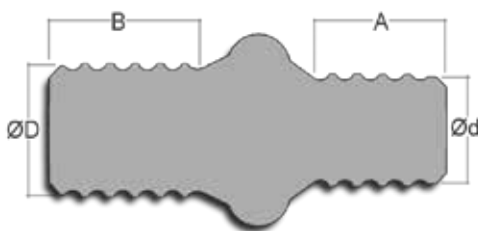
 **Double Flangeless plug 315 °C.**  
Protects threaded holes without masking the surrounding area. Useful for two different size

## DSSF



| CODICE CODE   | A     | Ød    | B     | ØD    | PCS BOX | €/BOX  |
|---|-------|-------|-------|-------|---------|--------|
|  DSSF6x8   | 7,93  | 5,40  | 7,95  | 7,00  | 500     | 115,46 |
|  DSSF10x12 | 9,33  | 9,00  | 11,74 | 10,80 | 100     | 61,50  |
|  DSSF14x16 | 12,00 | 12,60 | 14,40 | 14,50 | 50      | 75,31  |
|  DSSF18x20 | 16,80 | 16,50 | 18,60 | 18,40 | 50      | 130,23 |

5 boxes -20%



FORME E DIMENSIONI PERSONALIZZATE REALIZZABILI SU RICHIESTA

# WE SOLVE EVERY MASKING PROBLEM

**IT** **Tappi con rondella maggiorata 315 °C.**  
Ideale per mascherare la superficie attorno ad un foro.

**GB** **Silicone Large Size Flange Plugs 315 °C.**  
Ideal for masking holes and the grounding area around them.

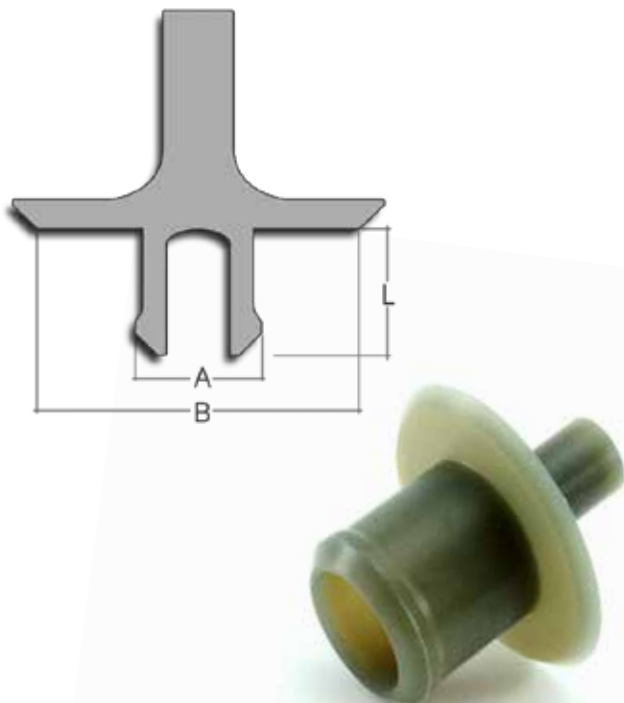

| CODICE CODE | A    | B    | L    | PCS BOX | €/BOX |
|-------------|------|------|------|---------|-------|
| FRMP4x7     | 3,7  | 7,0  | 4,1  | 500     | 51,09 |
| FRMP5x8     | 4,5  | 8,0  | 4,5  | 200     | 22,83 |
| FRMP6x10    | 5,6  | 10,0 | 5,5  | 200     | 29,36 |
| FRMP8x13    | 7,2  | 13,0 | 7,0  | 200     | 36,40 |
| FRMP10x16   | 9,3  | 16,0 | 9,5  | 100     | 27,34 |
| FRMP12x19   | 10,9 | 19,0 | 10,7 | 100     | 39,96 |
| FRMP14x22   | 12,8 | 22,0 | 11,3 | 100     | 42,86 |
| FRMP16x24   | 15,0 | 24,0 | 14,0 | 50      | 27,05 |
| FRMP18x27   | 16,9 | 27,0 | 16,4 | 25      | 16,94 |
| FRMP20x30   | 18,9 | 30,0 | 17,8 | 25      | 21,14 |

5 boxes **-20%**

FORME E DIMENSIONI **PERSONALIZZATE** REALIZZABILI SU RICHIESTA

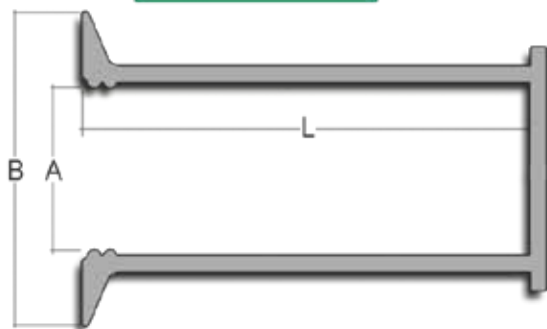

**IT** **Cappucci con flangia ad uso facilitato 315 °C.**  
Gli anelli alla base migliorano la tenuta del cappuccio e la flangia protegge la superficie alla base del perno.

**GB** **Flanged easy use caps 315 °C.**  
Internal ring improve cap tightness and the flange protect the area around the pin.

| CODICE CODE | A    | B    | L    | PCS BOX | €/BOX  |
|-------------|------|------|------|---------|--------|
| FZC4x9      | 3,5  | 9,0  | 25,0 | 250     | 53,47  |
| FZC5x10     | 4,5  | 10,0 | 50,0 | 250     | 97,45  |
| FZC6x12     | 5,5  | 12,0 | 50,0 | 250     | 111,14 |
| FZC8x16     | 7,4  | 16,0 | 50,0 | 250     | 136,71 |
| FZC10x20    | 9,4  | 20,0 | 50,0 | 100     | 66,69  |
| FZC12x24    | 11,3 | 24,0 | 50,0 | 100     | 79,02  |
| FZC14x28    | 13,4 | 28,0 | 50,0 | 100     | 91,35  |
| FZC16x30    | 15,4 | 30,0 | 50,0 | 50      | 51,66  |
| FZC18x34    | 17,4 | 34,0 | 50,0 | 50      | 59,00  |
| FZC20x36    | 19,4 | 36,0 | 50,0 | 50      | 65,06  |

5 boxes **-20%**

FORME E DIMENSIONI **PERSONALIZZATE** REALIZZABILI SU RICHIESTA



## PLASTRET







### Rete in PE per protezioni e imballi.

Rete a tubo in PE a sezione variabile, ideale per imballare e proteggere manufatti cilindrici di ogni tipo.



### PE net for protection and wrapping.

Variable size tube-shape PE net. Perfect to wrap and protect cylindrical shapes of all kinds

| CODICE CODE   | Ødmm | ØDmm | L mt | €/coil |
|---|------|------|------|--------|
|  PLASTRET07-12  | 7    | 12   | 25   | 26,46  |
|  PLASTRET12-25  | 12   | 25   | 25   | 47,99  |
|  PLASTRET25-45  | 25   | 45   | 25   | 89,61  |
|  PLASTRET45-70  | 45   | 70   | 25   | 129,58 |
|  PLASTRET70-120 | 70   | 120  | 25   | 202,07 |

5 boxes -20%

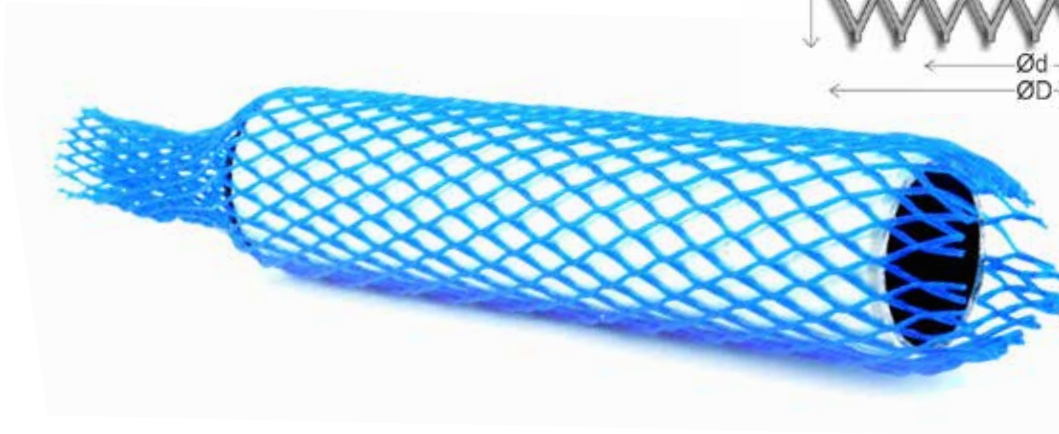
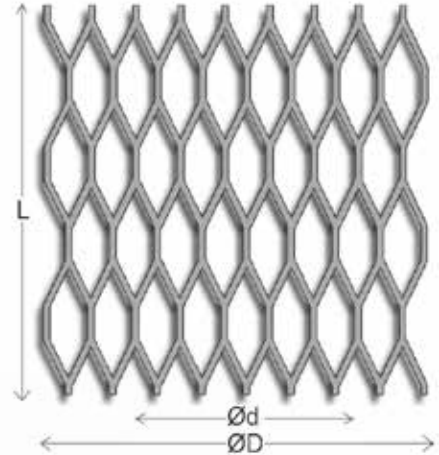

### Tendi-mascherina in Silicone

Adatto a tutte le mascherine chirurgiche, evita il contatto con le orecchie dando un maggiore confort nel vestire la mascherina. Regolabile in varie posizioni.



### Mask extender made in Silicone

Suitable for all surgery mask, release ear pressure giving confort while wearing the mask. Adjustable in many positions.

## Fit Mask

CODICE CODE

PCS BOX

€/box

FitMask Green

5

9,95



Colori Disponibili a Richiesta  
Other Colors Available on demand



# WE SOLVE EVERY MASKING PROBLEM

| Codice<br>Code   | Descrizione<br>Description   | Pag.<br>Page |
|--|--|--------------|
| <b>Nastri - Tapes - Rubans - Klebeband - Cintas - Fitas</b>  |  |              |
| SRT  | Nastro in Silicone - Silicone rubber tape  | 10           |
| HPT  | Nastro verde 204 °C - Green tape 204 °C  | 11           |
| EPR  | Nastro rosso 220 °C - Red tape 220 °C  | 11           |
| EPB  | Nastro blu 204 °C - Blue tape 204 °C   | 11           |
| EPTXL  | Nastro verde 204 °C lungh.500m - Green tape 204 °C 500mts length                       | 12           |
| STC  | Nastro trasparente 204 °C (0,065 mm)- Clear tape 204 °C (0,065 mm)                     | 12           |
| CLT  | Nastro trasparente 204 °C (0,09 mm)- Clear tape 204 °C (0,09 mm)                       | 12           |
| PC   | Nastro polimide 260 °C - Polyimide tape 260 °C   | 13           |
| EGC  | Nastro in tessuto di fibra di vetro 260 °C - Glass Cloth tape 260 °C                   | 13           |
| FLT  | Fine line tape - Fine line tape  | 13           |
| RPT  | Nastro verde 204 °C SILICONE FREE - Green Tape 204 °C SILICONE FREE                    | 14           |
| LALL65   | Nastro in alluminio con liner - Aluminium tape with liner                              | 14           |
| LALL70   | Nastro in alluminio laminato PET - Aluminium laminated tape                            | 14           |
| EPG  | Nastro per mascherature 140 °C - Masking tape 140 °C                                   | 15           |
| LPG  | Nastro in carta per mascheratura 80°C - Semi creped paper masking tape 80°C            | 15           |
| SPG  | Nastro in carta ad alta temperatura 190 °C - High temperature masking tape 190 °C      | 15           |
| <b>Fustellati adesivi - Engineered tape adhesive - Découpes de rubans adhésifs - Technisches für Stanzteile - Troqueles en cinta adhesiva - Corte em fita adhesiva</b> |  |              |
| EPCL   | Dischi adesivi con linguetta 204 °C - Adhesive discs with tab 204 °C                   | 16           |
| QPL  | Quadrati in nastro verde 204 °C - Square green tape 204 °C                             | 16           |
| RPL  | Rettangoli in nastro verde 204 °C - Rectangles green tape 204 °C                       | 16           |
| EPC  | Dischi adesivi in nastro verde 204 °C - Green adhesive discs 204 °C                    | 17           |
| CLD  | Bollini adesivi trasparenti 204 °C - Clear adhesive discs 204 °C                       | 17           |
| BPC  | Dischi adesivi polimide 260 °C - Polyimide adhesive discs 260 °C                       | 18           |
| EBC  | Bollini adesivi blu 204 °C - Blue adhesive discs 204 °C                                | 18           |
| EBV  | Bollini adesivi in vinile - White vinyl adhesive discs                                 | 19           |
| ELT  | Bollini adesivi in carta per mascheratura 80°C - Semi creped paper masking discs 80°C  | 19           |
| ---  | Fustellature di precisione in nastro 204 °C - Engineered precision tape die-cut 204 °C | 20           |
| ---  | Stampati speciali 300 °C - Engineered molded 300 °C                                    | 20           |
| <b>Tappi - Plugs - Bouchon - Stopfen - Tapones - Tampas</b>  |  |              |
| AFR  | Anelli, frammenti e rondelle - Rings, tube fragments and washers                       | 21           |
| TMF  | Tappo multi flangia - Multi flange plug  | 24           |
| DFPP   | Tappi speciali per protezione dadi - Nut protection special plug                       | 24           |
| CSINK  | Tappi speciali con flangia 315 °C - Countersink Plugs 315 °C                           | 24           |
| CPHS   | Tappi conici con maniglia 315 °C - Conical Plugs with handle 315 °C                    | 25           |
| ETM  | Tappi copri-filetto 315°C - Thread mask 315°C  | 25           |
| MHEP   | Tappo conico cavo con maniglia - Hollow conical plug with handle                       | 25           |
| WFP  | Tappi con rondella 315°C - Silicone Flange Plugs 315°C                                 | 26           |
| SP   | Tappi a gradino 315°C - Step Plugs 315°C   | 26           |
| FP   | Tappi senza flange 315 °C - Flangeless Plugs 315 °C                                    | 27           |

| Codice<br>Code  | Descrizione<br>Description  | Pag.<br>Page |
|---|---|--------------|
| HEP   | Tappi conici in silicone concavi 315°C - Hollow silicone plugs 315°C                        | 28           |
| CPP   | Tappi con maniglia di estrazione 315 °C - Pull Plugs 315 °C                                 | 29           |
| EPP   | Tappi EPDM con maniglia di estrazione 177 °C - EPDM Pull Plugs 177 °C                       | 30           |
| EP  | Tappi conici 315 °C - Conical Plugs 315 °C  | 31           |
| BP  | Tappi conici EPDM 177 °C - EPDM Conical Plugs 177°C   | 32           |
| VSP   | Tappi senza flangia ventilati 315 °C - Vent flangeless plug 315 °C                          | 41           |
| DHPP  | Tappi speciali doppia maniglia protezione dadi - Nut protection special plugs double handle | 42           |
| DSSF  | Tappi doppi senza flangia - Double flangeless plugs   | 42           |
| FRMP  | Tappi a rondella maggiorata - Large size flange plugs                                       | 43           |
| <b>Tubi, corde - Tubing, cord - Tubes, cordes - Schläuche, Rundschnur - Tubos, cordones - Tubos, fios</b>     |   |              |
| EST   | Tubo cavo per rivestimenti in polvere 315 °C - Tubing for Powder Coating 315 °C             | 22           |
| ETO   | Cordoncino pieno per rivestimenti in polvere 315 °C - Cord for Powder Coating 315 °C        | 22           |
| EZT   | Tubo a stella in silicone 315 °C - Silicone star tube 315 °C                                | 23           |
| ASC-QSC   | Corda in schiuma di silicone - Silicone foam cord   | 23           |
| <b>Cappucci - Caps - Capuchons - Kappen - Capuchones - Protetores</b>   |   |              |
| EC  | Rivestimenti in polvere Cappucci 315 °C - Powder Coating Caps 315 °C                        | 33           |
| EE  | Cappucci in E.P.D.M. 177 °C - E.P.D.M. Caps 177 °C  | 35           |
| EQ  | Cappucci copri-faston 315 °C - Square silicone caps 315 °C                                  | 37           |
| CBI   | Cappucci con anelli interni 315 °C - Caps with rings 315 °C                                 | 37           |
| CR  | Cappucci con flangia 315 °C - Caps with flange 315 °C                                       | 37           |
| FC  | Cappucci a testa piatta 315 °C - Flat caps 315 °C   | 38           |
| SZC   | Cappucci ad uso facilitato 315 °C - Easy use caps 315 °C                                    | 39           |
| CCC   | Cappucci conici a rondella 315 °C - Silicone Conecaps 315 °C                                | 40           |
| CF  | Cappucci a rondella 315 °C - Washer Caps 315 °C   | 40           |
| VRZC  | Cappucci ventilati ad uso facilitato - Vent easy use caps                                   | 41           |
| FZC   | Cappucci con flangia ad uso facilitato - Flanged easy use caps                              | 43           |
| <b>Altri prodotti - Other items - Autres produits - Sonstige Produkte - Otros productos - Outros produtos</b> |   |              |
| CUT   | Distributore automatico taglianastro - Automatic tape-cut dispenser                         | 8            |
| TAI   | Termometri adesivi monouso - Single-use adhesive thermometers                               | 8            |
| STICKRP01   | Stick per ritocco verniciatura a polvere - Custom made touch-up pencils for powder coating  | 8            |
| PRO   | Vernice spray - Spray paint   | 9            |
| AAP   | Pellicola autoadesiva trasparente - Clear adhesive film                                     | 10           |
| SKIT  | Starter kit - Starter kit   | 26           |
| PLASTRET  | Rete in PE per protezione - PE net for protection   | 44           |
| FIT MASK  | Tendi mascherina in silicone - Silicone mask extender                                       | 44           |
| <b>Ganci - Hooks - Crochets - Stahl - Ganchos - Ganchos</b>   |   |              |
| HC-HV-T5-T6   | Ganci per verniciatura in acciaio - Steel hooks for painting                                | 6            |
| SW  | Ganci girevoli - Swivel hooks   | 6            |
| GANCI VERT  | Ganci per verniciatura di profili in Al verticali - Hooks for vertical Al profiles painting | 7            |
| ---   | Ganci speciali - special Hooks  | 7            |

WE SOLVE EVERY MASKING PROBLEM

# EUROMASK®

IN THE WORLD

SEDE - UFFICI - PRODUZIONE  
PROGETTAZIONE - MAGAZZINO

**MILANO**  
ITALIA

🎯 FINISHING GROUP - SEDI

🌐 RIVENDITORI ESTERI

UFFICI - PRODUZIONE - MAGAZZINO

**CHRZANOW**  
POLONIA

**LERMA**  
MESSICO

UFFICI - MAGAZZINO

**DOBRA VODA**  
SLOVACCHIA

**SEVILLA**  
SPAGNA

**IASI**  
ROMANIA

**MASKLOGIK SLOVAKIA**  
phone +421 915 714 105  
info@masklogik.com

**MASKLOGIK MÉXICO**  
phone +52 728 284 0120  
Fax +52 728 284 0121  
info@masklogik.com.mx

**MASKLOGIK POLAND**  
phone +48 326 240 020  
Fax +48 326 240 020  
biuro@masklogik.com

**MASKLOGIK ROMANIA**  
phone +40 332 443 853  
Fax +40 332 443 853  
info@masklogik.com

**MASKLOGIK SPAIN - Fle&Mask S.L.**  
Movíl +34 657 577 965  
Móvil +34 603 216 058  
ventas@masklogik.com

# EUROMASK®

RISOLVIAMO OGNI PROBLEMA DI MASCHERATURA



# EUROMASK®

IN ITALIA

AGENTI  
&  
DISTRIBUTORI



**FINISHING GROUP s.r.l.**

Via A. de Gasperi, 31 - 20045 Lainate (MI) - Italia

**e-mail: [info@euromask-shop.com](mailto:info@euromask-shop.com)**

**[www.euromask-shop.com](http://www.euromask-shop.com)**

**Tel. +39 02 96780055 - 9691001 - n° verde 800.029.466**

**Fax +39 02 96782993**

**Forestami**

**Sostenitore 2021**

**La Missione:** Piantare 3 milioni di alberi entro il 2030 nel territorio della Città Metropolitana di Milano. Compensiamo la nostra produzione con una iniziativa concreta per contribuire con un impatto positivo sul nostro futuro e su quello delle generazioni a venire. Un contributo essenziale al benessere dei luoghi che abitiamo, in termini di benefici ambientali, economici e sociali e di miglioramento della qualità della vita.